

## Control and Load Switches for higher Capacities

CAD, CA and C type up to 315 A

L type up to 2400 A

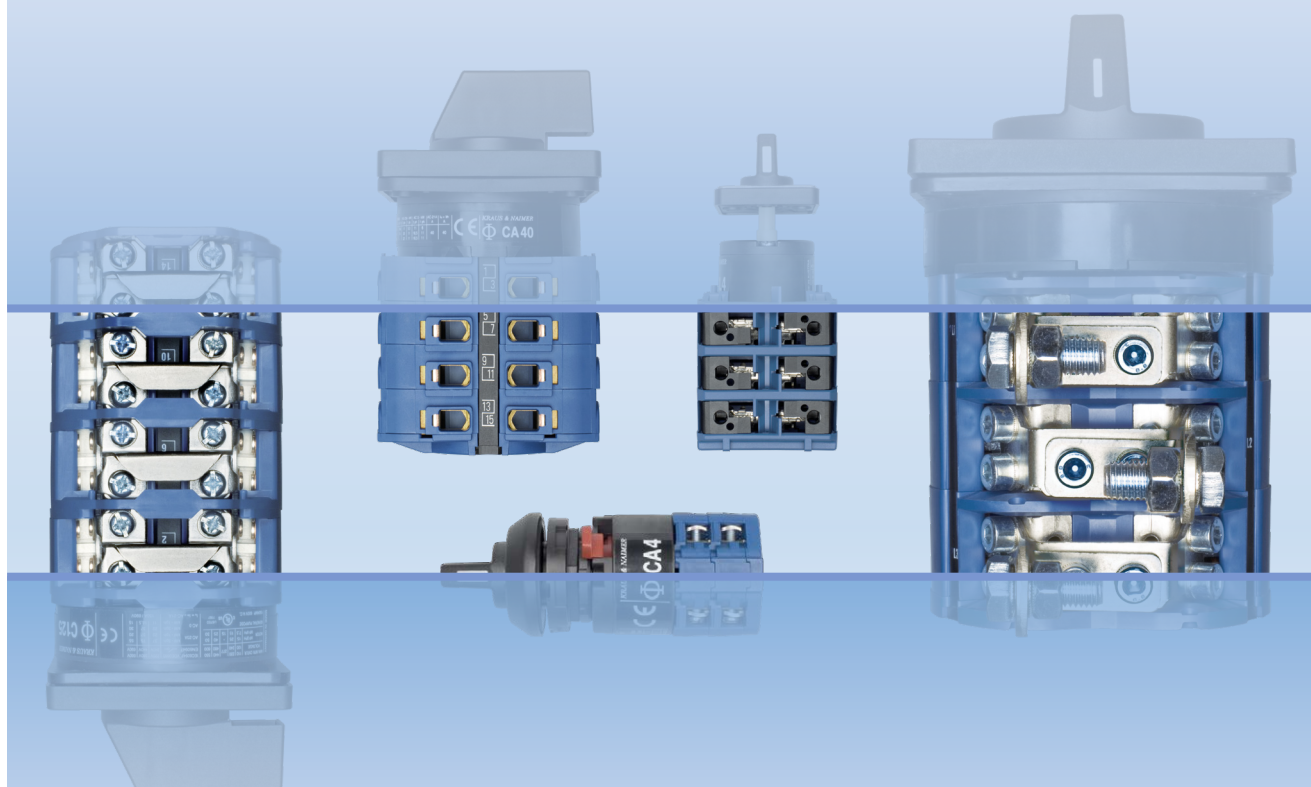

---

# Kraus & Naimer

The development of the Blue Line rotary switch and motor starter product ranges is based on more than hundred years experience by Kraus & Naimer in the design and manufacture of electrical switchgear. Kraus & Naimer pioneered the introduction of the cam operated rotary switch and continues to be recognized as the world leader in that product field.

## BLUE LINE

Blue Line products are protected by numerous patents through-out the industrial world. They are built to national and international standards and designed to withstand adverse temperatures and climates.

Blue Line products are accepted and universally recognized for their quality and workmanship. They are supported by a worldwide sales and service organization.

The Kraus & Naimer Registered Trademark

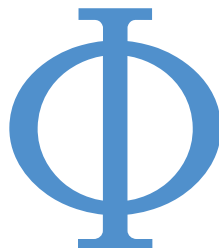

WORLDWIDE SYMBOL  
FOR QUALITY SWITCHGEAR

---

---

Disconnectors and Main Switches acc. to IEC 60947-3 see Catalog 500

<b>Contents</b>	<b>Page</b>
Construction Data	4
Dimensions and Nominal Ratings	5
How to order	6, 7
Switch Function and Configuration	
C, CA and CAD Switches 10 A-315 A	
ON/OFF Switches	9
Double-throw Switches	10-12
General Application Switches	12
Coding Switches	13
Multi-step Switches	14-16
Voltmeter Switches	17-18
Ammeter Switches	19-21
Volt-ammeter Switches	21
Control Switches	21, 22
Motor Switches	23-25
L Switches 350 A-2400 A	
ON/OFF Switches	26, 27
Double-throw Switches	28, 29
Multi-step Switches	30-32
Types of Mounting	
Panel Mounting	33-37
Base Mounting	38
Wall Mounting	39
Face Plates	40, 41
Handles	42
International Standards and Approvals	43
Technical Data	44-48
Dimensions	
Panel Mounting	49-53
Base Mounting	53, 54
Wall Mounting	55
Overall Switch Lengths	55, 56
Blue Line Switchgear: Summary	58

---

## Construction Data

The load switches of the C, CA and CAD-series offer a solution for most cam switch applications. Different contact designs, contact materials and terminals allow for their use as control switches, instrumentation switches and motor control switches, as well as in electronic circuitry and in aggressive environments according to IEC 60947-3 and VDE 0660 part 107.

The stage is the basis for all switches and can be supplied with a maximum of 2 contacts. The terminals are accessible from the side. CA and CAD switches are supplied with open terminals to facilitate wiring and are protected against accidental finger contact according to EN 50274, VDE 0660 part 514 and DGUV V3. Switches up to type CA25B are supplied with captive screws with clamping plates. The switch types CA40-CA63 are supplied with box terminals. Captive plus-minus terminal screws and integrated screwdriver guides facilitate wiring.

If a positive manual operation or a higher DC rating is required, many of these switches can be fitted with a snap action latching mechanism - suffix „S“ - to the switch type.

The cam-operated switches of the L-series are continuous current rated for off-load switching. They may be used to switch resistive or low inductive loads.

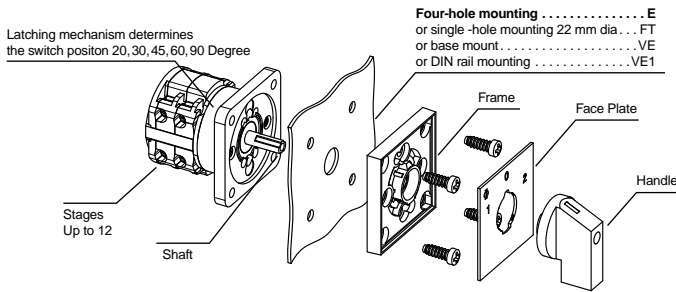

### Special Contact Systems

#### CA4/CA4-1

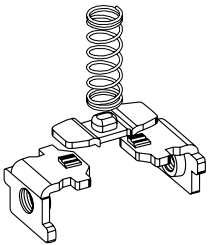

High contact reliability by multiple cross-point contacts, electronic compatible, CA4 with 1  $\mu$  and CA4-1 with 35  $\mu$  gold plating.

#### CAD4-1/CAD11/CAD12

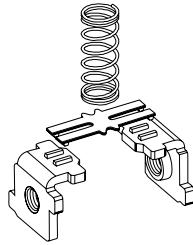

High contact reliability by H-bridge design with "cross-wire" contacts. The contact system with gold-plated contacts (CAD12 with silver contact) allows for low voltages, electronic compatible.

Type	Size	Possible Switching Angles	Max. No. of Stages
CA4, CA4-1, CAD4-1	S00	30°, 45°, 60°, 90°	9
CA10-CA25	S0	30°, 45°, 60°, 90°	12
CA10S-CA25S	S0	60°, 90°	on request
CAD11, CAD12	S0	30°, 45°, 60°, 90°	12
CA10B-CA25B	S1	30°, 45°, 60°, 90°	12
C26, C32, C42	S1	20°, 30°, 45°, 60°, 90°	12
C26S, C32S, C42S	S1	60°	on request
CA40, CA50, CA63	S1	30°, 45°, 60°, 90°	12
C43, C80, C125, C200-4	S2	20°, 30°, 45°, 60°, 90°	12
C315	S3	30°, 45°, 60°, 90°	12
L350, L351, L630, L631	S2	30°, 45°, 60°, 90°	12
L1000			
L400, L600, L800, L1200, L1600, L2000	S3	30°, 45°, 60°, 90°	12

### CA and CAD Switches (CA4-CA25B)



### CA Switches (CA40-CA63)



### C Switches



### L Switches



Above illustrates the standard terminal positions.

## Nominal Ratings

Switch Size	Type	According to IEC 60947-3/VDE 0660 part 107			
		Insulation Voltage <sup>1</sup> $U_i$ V	Thermal Current $I_u/I_{th}$ A	Motor Rating 3 x 380 V-440 V AC-23      AC-3 kW      kW	
<b>S00</b>  	<b>CA4</b>	440	10	3	2,2
	<b>CA4-1</b>	440	10	3	2,2
	<b>CAD4-1</b>	440	5	-	-
<b>S0</b>  	<b>CA10</b>	690	20	7,5	5,5
	<b>CA11</b>	690	20	7,5	5,5
	<b>CA20</b>	690	25	11	7,5
	<b>CA25</b>	690	32	15	11
	<b>CAD11</b>	600	6	-	-
	<b>CAD12</b>	600	6	-	-
<b>S1</b>  	<b>CA10B</b>	690	20	7,5	5,5
	<b>CA11B</b>	690	20	7,5	5,5
	<b>CA20B</b>	690	25	11	7,5
	<b>CA25B</b>	690	32	15	11
	<b>C26</b>	690	32	15	11
	<b>C32</b>	690	50	22	15
	<b>C42</b>	690	63	30	18,5
	<b>CA40</b>	690	40	18,5	15
	<b>CA50</b>	690	50	22	18,5
	<b>CA63</b>	690	63	30	18,5
<b>S2</b>  	<b>C43</b>	690	63	30	18,5
	<b>C80</b>	690	115	45	30
	<b>C125</b>	690	150	75	37
	<b>C200-4</b>	690	200	75	37
	<b>L350</b>	690	350	90	37
	<b>L351</b>	690	350	90	37
	<b>L630</b>	690	630 <sup>2</sup>	90	37
	<b>L631</b>	690	630 <sup>2</sup>	90	37
	<b>L1000</b>	690	1000 <sup>2</sup>	90	37
	<b>S3</b>  	<b>C315</b>	690	315	132
<b>C316<sup>3</sup></b>		1000	315	132	55
<b>L400</b>		690	500	132	55
<b>L600</b>		690	800 <sup>2</sup>	132	55
<b>L800</b>		690	1100 <sup>2</sup>	132	55
<b>L1200</b>		690	1450 <sup>2</sup>	132	55
<b>L1600</b>		690	1900 <sup>2</sup>	132	55
<b>L2000</b>	690	2400 <sup>2</sup>	132	55	

For further technical details, refer to pages 44-47.  
To furnish with gold contacts and quick connects see page 6.

<sup>1</sup>Valid for lines with grounded common neutral termination, overvoltage category III, pollution degree 3. Values for other supply systems on request. <sup>2</sup>Ambient temperature 35 °C max. <sup>3</sup>Additional switch functions on request.

## How to order

Disconnectors and Main Switches according to IEC 60947-3 see Catalog 500

Three types of data (shown below) are required for ordering Blue Line cam-operated switches. Code numbers for ordering are shown in this catalog.

### 1. Type of Switch

The type of switch required may be easily selected by referring to the table on page 5 which shows the thermal current, power rating and dimensions of each switch. For further technical details, refer to pages 44-47. Variations of contacts and terminals are shown below.

### 2. Switch Function

The code numbers for standard switches shown on pages 8-32 indicate the switch function, face plate, handle and any optional extras.

Additional coding to modify type and color of handle and face plate is explained below.

### 3. Type of Mounting

Types of mounting are shown on pages 33-39. Catalog **101** describes enclosures and optional extras.

Specify the mounting code to indicate required mounting.

**CA10**

**A202**

**VE**

## Type of Switch

Extending the switch type coding the following combinations will define:

Amendment	Definition	For switch types
-1	with gold contacts <sup>1</sup>	CA4-1, CA4N-1, CA10-1, CA11-1, CA10B-1, CA11B-1, CAD4-1
-4	with quick connects	CA4-4
B <sup>2</sup>	S0 switches with latching mechanism size S1	CA10B, CA11B, CA25B, CAD11B, CAD12B
C <sup>2</sup>	S1 switches with latching mechanism size S2	CA40C, CA50C, CA63C
L	with lockout-relay w/o manual release for std. sw.	CA10L, C25L, C26L, CA40L, CA50L, CA63L
M	with lockout-relay with manual release for std. sw.	CA10M, C25M, C26M, C42M, CA40M, CA50M, CA63M
X	with power failure release	CA10X, CA20X, CA25X, C26X, C32X, C42X, CA40X, CA50X, CA63X
Y	with power failure release and trip-free release	CA10Y, CA20Y, CA25Y
S <sup>2</sup>	with snap action	CA10S, CA20S, CA25S with 60° or 90° switching C26S, C32S, C42S, CA40S, CA50S, CA63S with 60° switching
R	with spring return latching mechanism	CA10R, CA25R, CAD11R, CAD12R

**Example:** Coding for switch type **CA10** with gold contacts is **CA10-1**.

## Handles, Face Plates and Optional Extras

The handles for standard switches shown on pages 8-32 are suitable for mounting units with four hole mounting. Alternative types of handles available are illustrated on page 42, and mounting units on pages 31-37.

When a handle, face plate or optional extra is required but not covered by the dash number, the code number for the selected component should be entered separately. A comprehensive range of available standard face plates is illustrated on pages 40 and 41. Non-standard or special face plate engravings are available at extra cost.

The large number of optional extras and enclosures is covered in Catalog **101**.

## Switch Size

Blue Line switches are available in sizes S00, S0, S1, S2 and S3. These size codes indicate the dimensions of the mounting, the face plate and the handle, as well as the size of optional devices and enclosures.

Page 5 lists these sizes and the various switch types they include.

<sup>1</sup>Technical data on request. <sup>2</sup>Additional length for switches with B, C, S, amendments refer page 54.



**Notes:**

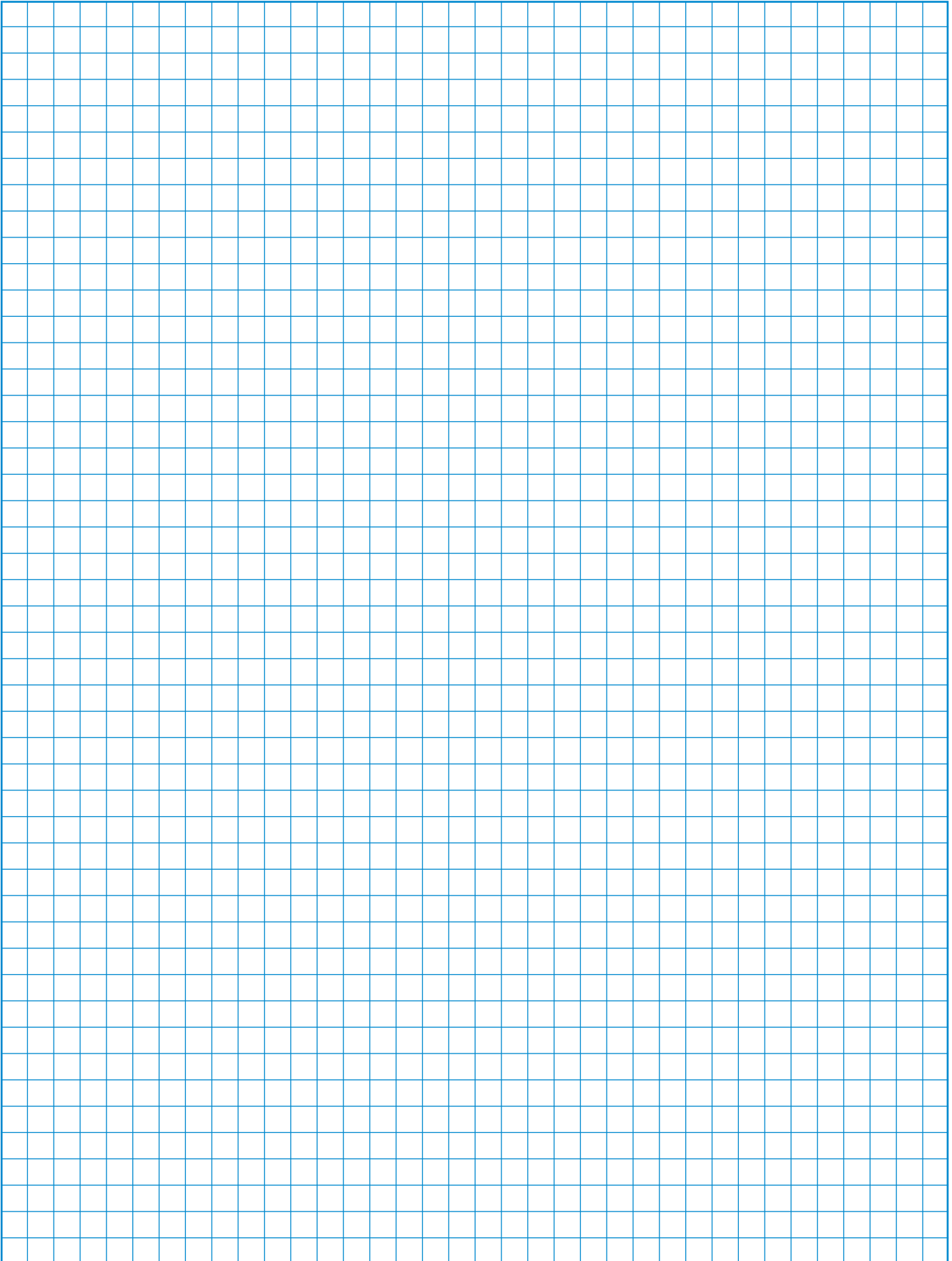















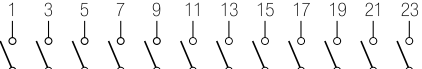









































[< back to table of contents >](#)



Function	Escutch. Plate	Type/Handle				Code	Stages	Connection Diagram
		CA4 CA4-1 CAD4-1	CAD.. CA10- CA25	CA10B- CA25B	CA40 C26- C315			





































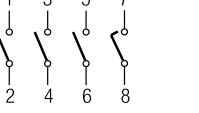

**ON/OFF Switches with 60° Switching**

[Dimensions p.56](#)















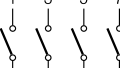



















1 pole	 F070					A200	1	
2 pole						A201	1	
3 pole						A202	2	
4 pole						A203	2	
4 pole 1 pole preclose 6° <sup>1</sup>						WAA653	2	
5 pole						WAA341	3	
6 pole						A342	3	
7 pole						A343	4	
8 pole						A344	4	
8 pole 2 pole preclose 6° <sup>1</sup>						WAA654	4	
9 pole						WAA345	5	
10 pole						A346	5	
11 pole					WAA347	6		
12 pole					A348	6		

**ON/OFF Switches with 90° Switching**

[< back to table of contents >](#)

1 pole contacts	 F066					A290	1	
2 pole preclose 30°						A291	1	
3 pole						A292	2	
4 pole						A324	2	
4 pole 1 pole preclose 60° <sup>1</sup>						A293	2	
4 pole 3 pole preclose 30°						WAA327	2	
5 pole contacts	 F062					WAA325	3	
6 pole preclose 30°						A326	3	
3 pole 360° rotation						WAA208	2	

**ON/OFF Switches with 30° Switching**







































































1 pole	 F169					WAA100	1	
2 pole						WAA101	1	
3 pole						WAA102	2	
4 pole						WAA103	2	
1 pole with spring return	 F153					A204	1	
2 pole with spring return						A205	1	
3 pole with spring return						WAA206	2	
4 pole with spring return						WAA207	2	

<sup>1</sup>for use in a three phase four-wire system with switched neutral    <sup>2</sup>not available for switch type CA25    <sup>3</sup>not available for switch type C315

Function	Escutch. Plate	Type/Handle				Code	Stages	Connection Diagram
		CA4 CA4-1 CAD4-1	CAD.. CA10- CA25	CA10B- CA25B	CA40 C26- C315			































Double-throw Switches without „OFF“ 60° Switching

[Dimensions p.56](#)





































1 pole	 F072					A220	1	
2 pole						A221	2	
3 pole						A222	3	
4 pole						A223	4	
4 pole 1 pole preclose 6° <sup>2</sup>						WAA673	4	
5 pole						A369	5	
6 pole						A370	6	
7 pole						A371	7	
8 pole						A372	8	
8 pole 2 pole preclose 6° <sup>2</sup>						WAA972	8	
9 pole						WAA373	9	
10 pole						WAA374	10	
11 pole					WAA375	11		
12 pole					WAA376	12		

[< back to table of contents >](#)

Double-throw Switches without „OFF“ with electrically isolated contacts

1 pole	 F072					A720	1	
2 pole						A721	2	
3 pole						A722	3	
4 pole						A723	4	
4 pole 1 pole preclose 6° <sup>2</sup>						WAA973	4	
1 pole with spring return	 F026					A795	1	

Double-throw Switches without „OFF“ 30° Switching















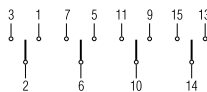























1 pole	 F026					WAA120	1	
2 pole						WAA121	2	
3 pole						WAA122	3	
4 pole						WAA123	4	
1 pole with spring return	 F026					A295	1	
2 pole with spring return						A296	2	
3 pole with spring return						WAA297	3	

<sup>1</sup>not available for switch type CA25    <sup>2</sup>for use in a three phase four-wire system with switched neutral

Function	Escutch. Plate	Type/Handle	Code	Stages	Connection Diagram
		CA4 CAD.. CA4-1 CA10- CA10B- C80- CAD4-1 CA25 CA63 C315			



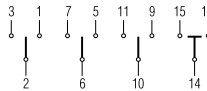
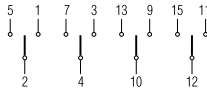
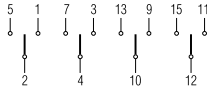

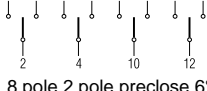













Double-throw Switches with Center „OFF“ 60° Switching

[Dimensions p.56](#)



























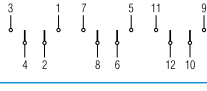

1 pole	 <p>F071</p>					A210	1	 <p>1-4 pole</p>
2 pole						A211	2	
3 pole						A212	3	
4 pole						A213	4	
4 pole 1 pole preclose 6° <sup>3</sup>						WAA913	4	
5 pole						A361	5	
6 pole						A362	6	
7 pole						WAA363	7	
8 pole 2 pole preclose 6° <sup>3</sup>						WAA364 WAA664	8	
								 <p>4 pole 1 pole preclose 6°</p>
								 <p>5 pole</p>
								 <p>6 and 7 pole</p>
								 <p>8 pole</p>
								 <p>8 pole 2 pole preclose 6°</p>

[< back to table of contents >](#)

Double-throw Switches with Center „OFF“ 90° Switching

1 pole	 <p>F057</p>					A218	1	 <p>1-4 pole</p>
2 pole						A219	2	
3 pole						WAA299	3	
4 pole 1 pole preclose 60° <sup>3</sup>						WAA294	4	

Double-throw Switches with Center „OFF“ and electrically isolated contacts

























1 pole	 <p>F071</p>					A710	1	 <p>1-4 pole</p>
2 pole						A711	2	
3 pole						A712	3	
4 pole 1 pole preclose 6°						A713 WAA963	4	
4 pole 1 pole preclose 6°								 <p>4 pole 1 pole preclose 6°</p>
1 pole with spring return to center	 <p>F025</p>					A714	1	 <p>1 and 2 pole</p>
2 pole						A715	2	

<sup>1</sup>switch type C315 with  handle    <sup>2</sup>not available for switch type C315    <sup>3</sup>for use in a three phase four-wire system with switched neutral





















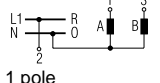
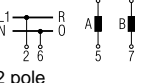
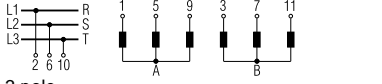









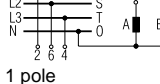
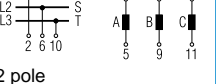
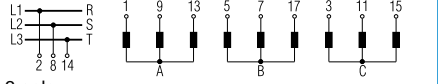







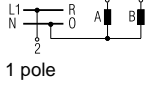
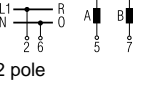
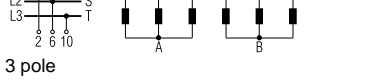

Function	Escutch. Plate	Type/Handle	Code	Stages	Connection Diagram
		CA4 CAD.. CA40 CA4-1 CA10- C26- CAD4-1 CA25 CA25B C315			

## Double-throw Switches with Spring Return to Center

[Dimensions p. 56](#)

1 pole with spring return 2 pole to center 3 pole		  	  	  	 <sup>2</sup>  <sup>3</sup>	A214 A215 A216	1 2 3	 1-3 pole
1 pole with spring return 2 pole from left to center 3 pole		  	  	  		A320 A321 A322	1 2 3	 1-3 pole

## General Application Switches

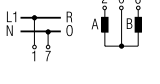
1 pole 2 Gang 2 pole Switching sequence: 3 pole 0, A, A+B		  	  	  		A310 A312 WAA314	1 2 3	 1 pole  2 pole  3 pole
1 pole 3 Gang 2 pole Switching sequence: 3 pole 0, A, A+B, A+B+C		  	  	  		A311 WAA313 WAA315	2 3 5	 1 pole  2 pole  3 pole
1 pole 2 Gang 2 pole Series switching 3 pole Switching sequence: 0, A, B, A+B		  	  	  		WAA330 WAA331 WAA332	1 2 3	 1 pole  2 pole  3 pole
2 pole 2 Gang Series-parallel Switching Switching sequence: 0, A+B series, A, A+B parallel		  	  	  		WAA339	2	 2 pole













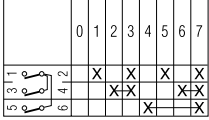



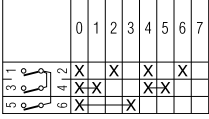



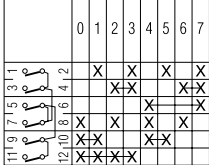



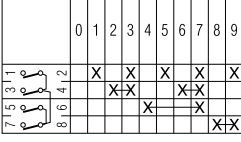



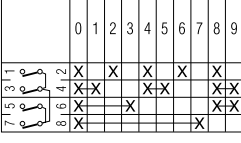

<sup>1</sup>not available for switch type CA25 <sup>2</sup>not available for switch type C315 <sup>3</sup>available only up to switch type CA63

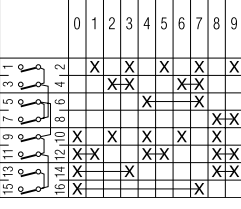
Function	Escutch. Plate	Type/Handle				Code	Stages	Connection Diagram
		CA4 CA4-1 CAD4-1	CA10 CA11 CA12	CA10B- CA25B	CA40 C26- C315			

Coding Switches/Binary Code

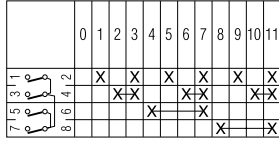
[Dimensions p.56](#)



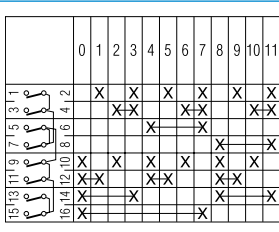































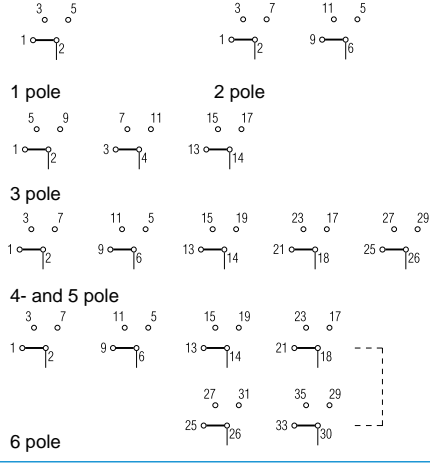

























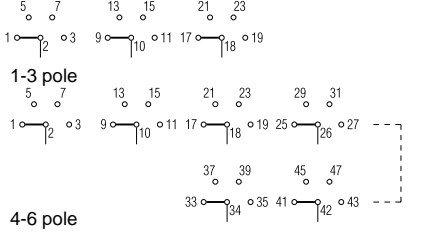

















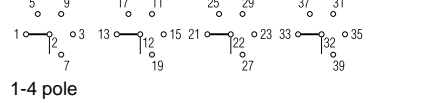













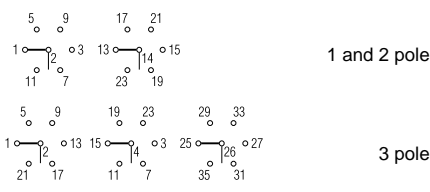













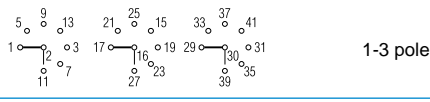













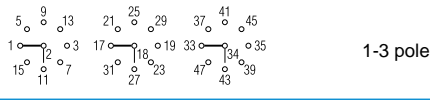





























< back to table of contents >

0 - 7 360° rotation	 F322				A540	2	
0 - 7 complement 360° rotation	 F322				WAA541	2	
0 - 7 + complement 360° rotation	 F322				WAA542	3	
0 - 9	 F007				A550	2	
0 - 9 complement	 F007				WAA551	2	
0 - 9 + complement	 F007				WAA552	4	
0 - 11 360° rotation	 F009				A543	2	
0 - 11 + complement 360° rotation	 F009				WAA545	4	

Function	Escutch. Plate	Type/Handle				Code	Stages	Connection Diagram
		CA4 CA4-1 CAD4-1	CAD.. CA10- CA25	CA10B- CA63	C80- C315			

Multi-step Switches without „OFF“

Dimensions p. 56

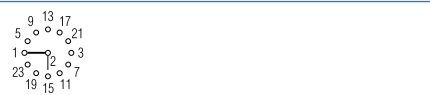
1 pole 3 Step 2 pole 3 pole 4 pole 5 pole 6 pole	 F076	     	     	     	     	A230 A250 A270 A476 WAA484 WAA489	2 3 5 6 8 9	
1 pole 4 Step 2 pole 3 pole 4 pole 5 pole 6 pole	 F077	     	     	     	     	A231 A251 A271 A477 WAA485 WAA490	2 4 6 8 10 12	
1 pole 5 Step 2 pole 3 pole 4 pole	 F078	   	   	   	   	A232 A252 WAA272 WAA478	3 5 8 10	
1 pole 6 Step 2 pole 3 pole	 F079	  	  	  	  	A233 WAA253 WAA273	3 6 9	
1 pole 7 Step 2 pole 3 pole	 F110	  	  	  	  	WAA234 WAA254 WAA274	4 7 11	
1 pole 8 Step 2 pole 3 pole	 F111	  	  	  	  	WAA235 WAA255 WAA275	4 8 12	
1 pole 9 Step	 F010	 	 	 	 	WAA236	5	
1 pole 10 Step	 F011	 	 	 	 	WAA237	5	
1 pole 11 Step	 F012	 	 	 	 	WAA238	6	
1 pole 12 Step 1 pole 360° rotation	 F013	 	 	 	 	WAA239 WAA639	6 6	

< back to table of contents >

<sup>1</sup>switch type C315 with  handle <sup>2</sup>not available for switch type CA11B











Function	Escutch. Plate	Type/Handle	Code	Stages	Connection Diagram
		CA4 CAD.. CA4-1 CA10- CA10B- C80- CAD4-1 CA25 CA63 C315			

Multi-step Switches without „OFF“ with electrically isolated contacts

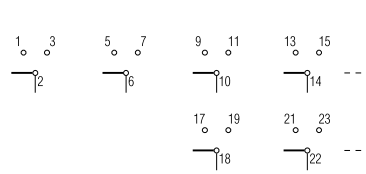
[Dimensions p.56](#)

1 pole 3 Step	 F076					A730	2	 1 pole  2 pole
2 pole						A750	3	
1 pole 4 Step	 F077					A731	2	 1 pole  2 pole
2 pole						A751	4	

Multi-step Switches with „OFF“

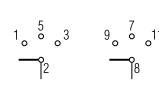
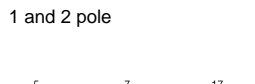
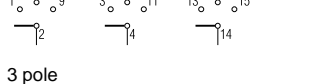
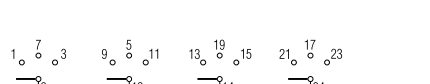























































































































1 pole 2 Step 2 pole 3 pole 4 pole 5 pole 6 pole	 F075					A240 A260 A280 WAA480 WAA486 WAA491	1 2 3 4 5 6	 1-6 pole
1 pole 3 Step 2 pole 3 pole 4 pole 5 pole	 F109					A241 A261 A281 WAA481 WAA487	2 3 5 6 8	 1 and 2 pole  3 pole  4 pole  5 pole

[< back to table of contents >](#)

Function	Escutch. Plate	Type/Handle				Code	Stages	Connection Diagram
		CA4 CA4-1 CAD4-1	CAD. CA10- CA25	CA10B- CA63	C80- C315			

Multi-step Switches with „OFF“

[Dimensions p. 56](#)

1 pole 4 Step 2 pole 3 pole 4 pole	 F002	   	   	   	A242 WAA262 WAA282 WAA482	2 4 6 8	    1-4 pole
1 pole 5 Step 2 pole 3 pole	 F003	   	   	   	A243 WAA263 WAA283	3 5 8	   1-3 pole
1 pole 6 Step 2 pole 3 pole	 F004	   	   	   	A244 WAA264 WAA284	3 6 9	   1-3 pole
1 pole 7 Step 2 pole	 F005	   	   	   	WAA245 WAA265	4 7	  1 pole                      2 pole
1 pole 8 Step	 F006	   	   	   	WAA246	4	
1 pole 9 Step	 F007	   	   	   	WAA247	5	
1 pole 10 Step	 F008	   	   	   	WAA248	5	
1 pole 11 Step 1 pole 360° rotation	 F009	   	   	   	WAA249 WAA649	6 6	

[< back to table of contents >](#)











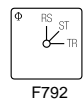

# Switch Function and Configuration

# C, CA, CAD Switches



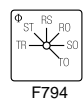



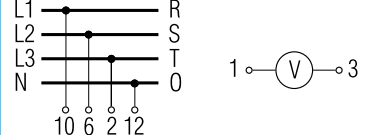



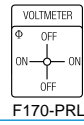

Function	Escutch. Plate	Type/Handle	Code	Stages	Connection Diagram
		CA4 CA4-1 CA10- CAD4-1 CA25 CAD..	CA10B- CA25B		

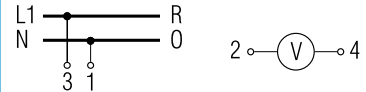
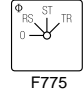
## Voltmeter Switches without „OFF“

[Dimensions p.56](#)

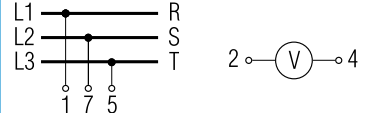
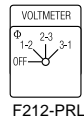
3 phase 3 wire	 F792					A023	2	
3 phase 3 wire 3 phase to phase and phase to neutral	 F794					A025	3	

## Voltmeter Switches with „OFF“

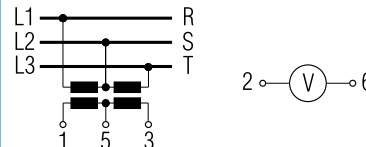













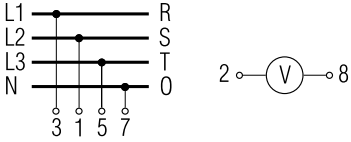





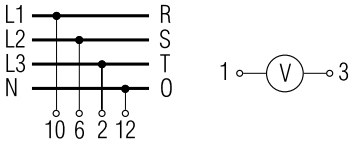

2 pole 360° rotation	 F170-PRL					WAA002	1	
3 phase 3 wire	 F775					A004	2	
	 F212-PRL					WAA011	2	

[< back to table of contents >](#)

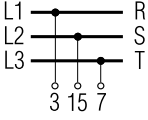
Function	Escutch. Plate	Type/Handle				Code	Stages	Connection Diagram
		CA4 CA4-1 CAD4-1	CA10- CA25	CAD..	CA10B- CA25B			

Voltmeter Switches with „OFF“

[Dimensions p.56](#)

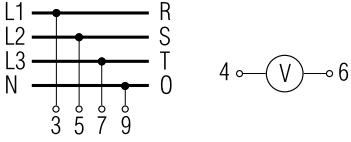









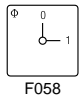



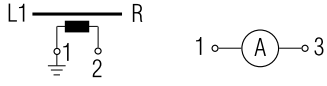
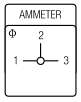



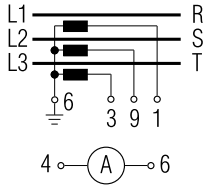





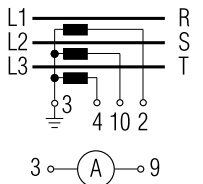
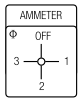

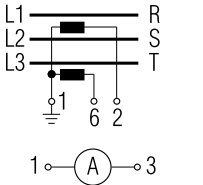
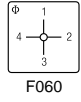

3 phase to neutral	 F779					WAA005	2	
3 phase to phase and 3 phase to neutral	 F782					A007	3	
2 separate 3 phase with center „OFF“	 F786					WAA008	4	 
3 phase and 1 phase to neutral	 F789					WAA010	3	

[< back to table of contents >](#)

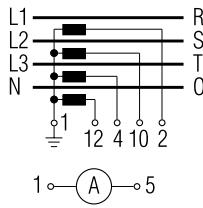
Function	Escutch. Plate	Type/Handle	Code	Stages	Connection Diagram
	CA4 CA4-1 CAD4-1	CAD.. CA10- CA25	CA10B- CA63 C32	C43- C125	

**Ammeter Switches**

[Dimensions p.56](#)

Single pole with one current transformer	 F058					WAA046	1	
Single pole with 3 current transformers without „OFF“	 F181-PRL					WAA017	3	
Single pole with 3 current transformers with „OFF“ 360° rotation	 F059					A048	3	
Single pole with 2 current transformers (3 readings)	 F172-PRL					WAA021	2	
Single pole with 4 current transformers	 F060					WAA036	4	
2 pole 2 current transformers	 F057					WAA037	3	

[< back to table of contents >](#)

<sup>1</sup>available only up to switch type CA25B











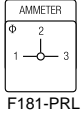

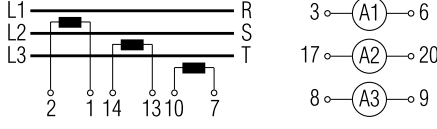

# Switch Function and Configuration

# C, CA, CAD Switches

Function	Escutch. Plate	Type/Handle	Code	Stages	Connection Diagram
		CA4 CAD. CA10B- CA4-1 CA10- CA63- CAD4-1 CA25 C42 C43- C125			

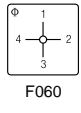
## Ammeter Switches

[Dimensions p. 56](#)

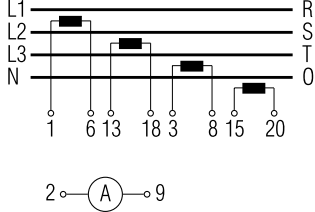





2 pole 3 current transformers	 F181-PRL					WAA019	5	
	 F059						A038	5
2 pole 4 current transformers	 F060					WAA039	6	

<sup>1</sup>available only up to switch type CA25B

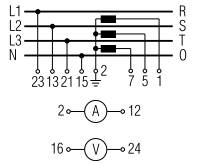
Funktion	Switch- Prinzip	Type/Griff CA4 CA4-1 CAD.. CA10- CAD4-1 CA25 CA10B- CA25B	Code	Fluch- Stages ten	Commons Anschlüsse Diagram
----------	--------------------	--	------	-------------------------	----------------------------------

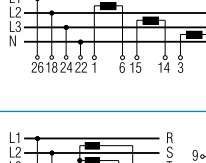

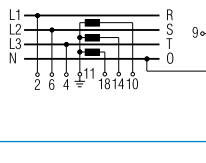

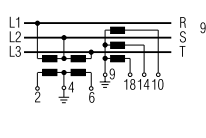



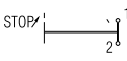

Volt-ammeter Switches

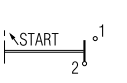
Dimensions p.56

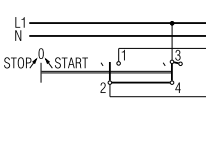
3 phase - phase to phase 3 current	 F101				WAA027	6	
3 phase voltage 3 phase current 4 wire	 F077			1	WAA028	7	
3 phase voltage 3 phase current 4 wire	 F174-PRL			1	WAA033	5	
3 phase voltage 3 phase current 3 wire	 F174-PRL			1	WAA035	5	

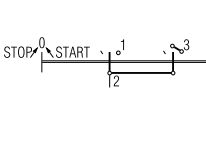
[< back to table of contents >](#)

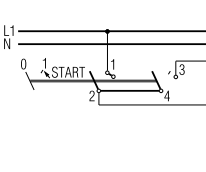
Control Switches

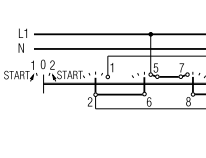









Stop switch	 F022			1	WAA174	1	
Start switch	 F023			1	A175	1	
Stop start switch single pole	 F024			1	A176	1	
Stop start switch 2 pole	 F024				WAA183	2	
Stop start switch with spring return from start to run	 F119				A178	1	
Stop start switch with spring return to run for 2 units	 F121			1	WAA177	2	

<sup>1</sup>available only up to switch type CA25B

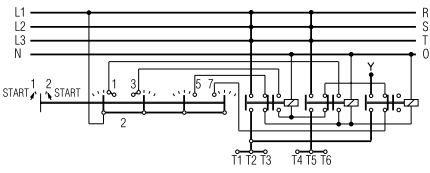













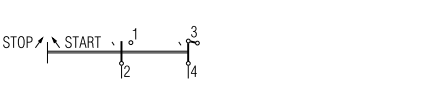





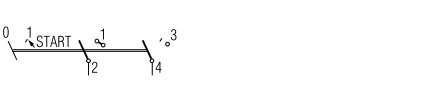



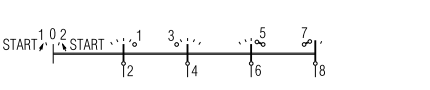

Function	Escutch. Plate	Type/Handle	C26- C43 CA40- CA63	Code	Stages	Connection Diagram
		CA4 CAD.. CA4-1 CA10- CAD4-1 CA25 CA25B				

Control Switches



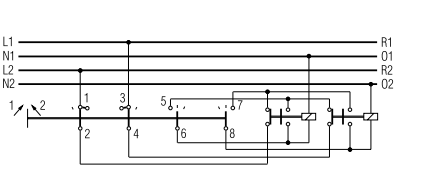

Dimensions p. 56

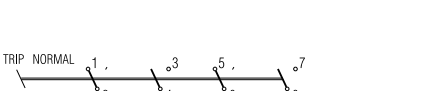
Stop start switch with spring return to run with contactor interlock contactors for 2 units	 F121					WAA182	2	
Motor voltage control switch	 F144-PRL					WAA150	2	

Control Switches with electrically isolated contacts

Stop start switch single pole	 F024					A789	1	
Stop start switch with spring return to 1	 F119					A791	1	
Stop start switch with spring return to run for 2 units	 F121					WAA790	2	
Contactor control with spring return to „OFF“	 F025					WAA179	2	
Circuit breaker control	 F143-PRL					WAA537	2	

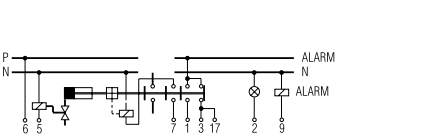
Control and Alarm Switches<sup>1</sup>

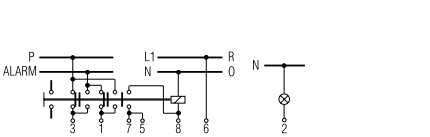
With slip clutch and without indicator device						WAA190	5 <sup>3</sup>	
Without indicator device						WAA192	2	

<sup>1</sup>Advise the indicator device, described in Catalog 101, page 9. <sup>2</sup>not available for switch types CA25 and CA25B <sup>3</sup>incl. slip clutch <sup>4</sup>available only up to switch type CA40

Function	Escutch. Plate	Type/Handle	Code	Stages	Connection Diagram
	CA4 CA4-1 CAD4-1	CAD. CA10- CA25	CA..B C26-C43 CA40-CA63 C80- C315		

## Motor Reversing Switches

[Dimensions p.56](#)

2 pole						A400	2	
3 pole						A401	3	
3 pole with spring return to „OFF“						A228	3	
3 pole for use with reversing contactors						WAA402	4	

[< back to table of contents >](#)

## Motor Control Switches















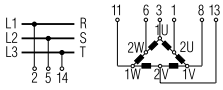
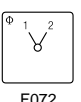



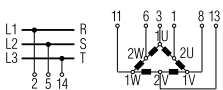





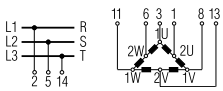



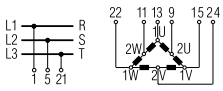

2 speed 2 winding 0-A-B $\Upsilon$ or $\Delta$						WAA451	3	
3 speed 2 winding 0-A-B $\Upsilon$ or $\Delta$						WAA457	6	

<sup>1</sup>not available for switch type CA25    <sup>2</sup>not available for switch types C26-C43, CA40-CA63    <sup>3</sup>available only up to switch type CA50

Function	Escutch. Plate	Type/Handle	Code	Stages	Connection Diagram
		CA4 CAD.. CA40 CA4-1 CA10- C26- CAD4-1 CA25 CA25B C315			

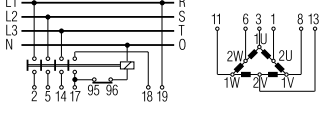
## Motor Control Switches

[Dimensions p. 56](#)

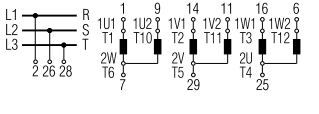
2 speed single winding						A440	4	
2 speed single winding without „OFF“						A466	4	
2 speed single winding with center „OFF“						A441	4	
2 speed single winding reversing						A442	6	
2 speed single winding for use with contactors						WAA444	5	
2 speed reversing for 2 way operation with slip clutch for „OFF“ load use						WAA468	10 <sup>1</sup>	

<sup>1</sup>incl. slip clutch

[< back to table of contents >](#)



Function	Escutch. Plate	Type/Handle				Code	Stages	Connection Diagram
		CA4 CA4-1 CAD4-1	CAD. CA10- CA25	CA..B C26-C43 CA40-CA63	C80- C315			

Star-delta Switches

[Dimensions p.56](#)

OFF-star-delta						A410	4	
Reversing						WAA413	5	
With auxiliary contact closed in „OFF“ position						WAA416	5	
For use with reversing contactors						A419	4	

[< back to table of contents >](#)

Start and Run Switches

Split-phase start						A425	2	
Split-phase start reversing					<sup>1</sup>	WAA426	3	
Split-phase reversing auto cutout of start field winding						WAA622	3	

<sup>1</sup>not available for switch type CA25

Function/Type	Escutch. Plate	Handle	Code	Stages	Double Latching	Connection Diagram	L350 L630 L1000	L351 L631
---------------	----------------	--------	------	--------	-----------------	--------------------	-----------------------	--------------

## ON/OFF Switches with 60° Switching

[Dimensions p. 56](#)

1 pole 2 pole 3 pole 4 pole	L350			WAA200 WAA201 WAA202 WAA203	1 2 3 4			1-4 pole
1 pole 2 pole 3 pole 4 pole	L351			WAA200 WAA201 WAA202 WAA203	1 2 3 4			1-4 pole
1 pole 2 pole 3 pole 4 pole	L400			WAA200 WAA201 WAA202 WAA203	2 2 4 4			1-4 pole
3 pole with lugs suitable for protective cover				WAA302	3			WAA302
1 pole 2 pole 3 pole 4 pole	L600			WAA200 WAA201 WAA202 WAA203	3 3 6 6			1-4 pole
1 pole 2 pole 3 pole 4 pole	L630			WAA200 WAA201 WAA202 WAA203	2 4 6 8	● ●		1-4 pole
1 pole 2 pole 3 pole 4 pole	L631			WAA200 WAA201 WAA202 WAA203	2 4 6 8	● ●		1-4 pole
1 pole 2 pole 3 pole 4 pole	L800			WAA200 WAA201 WAA202 WAA203	2 4 6 8			1-4 pole
1 pole 2 pole 3 pole 4 pole	L1000			WAA200 WAA201 WAA202 WAA203	3 6 9 12	● ● ●		1-4 pole
1 pole 2 pole 3 pole	L1200			WAA200 WAA201 WAA202	3 6 9			1-3 pole
1 pole 2 pole 3 pole	L1600			WAA200 WAA201 WAA202	4 8 12			1-3 pole
1 pole 2 pole	L2000			WAA200 WAA201	5 10	●		1 and 2 pole

< back to table of contents >

Function/Type	Escutch. Plate	Handle	Code	Stages	Double Latching	Connection Diagram	L350 L630 L1000	L351 L631
---------------	----------------	--------	------	--------	-----------------	--------------------	-----------------------	--------------

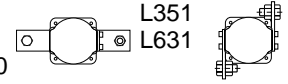

## ON/OFF Switches with 90° Switching

[Dimensions p. 56](#)

1 pole 2 pole 3 pole 4 pole	L350 1 pole preclose 60°			WAA290 WAA291 WAA292 WAA293	1 2 3 4			1-4 pole
1 pole 2 pole 3 pole 4 pole	L351 1 pole preclose 60°			WAA290 WAA291 WAA292 WAA293	1 2 3 4			1-4 pole
1 pole 2 pole 3 pole 4 pole	L400 1 pole preclose 60°			WAA290 WAA291 WAA292 WAA293	2 2 4 4			1-4 pole
3 pole	with lugs suitable for protective cover			WAA307	3			WAA307
3 pole	360° rotation			WAA208	4			WAA208
1 pole 2 pole 3 pole 4 pole	L600 1 pole preclose 60°			WAA290 WAA291 WAA292 WAA293	3 3 6 6			1-3 pole 4 pole
1 pole 2 pole 3 pole 4 pole	L630 1 pole preclose 60°			WAA290 WAA291 WAA292 WAA293	2 4 6 8			1-3 pole 4 pole
1 pole 2 pole 3 pole 4 pole	L631 1 pole preclose 60°			WAA290 WAA291 WAA292 WAA293	2 4 6 8			1-3 pole 4 pole
1 pole 2 pole 3 pole 4 pole	L800 1 pole preclose 60°			WAA290 WAA291 WAA292 WAA293	2 4 6 8	● ● ●		1-3 pole 4 pole
1 pole 2 pole 3 pole 4 pole	L1000 1 pole preclose 60°			WAA290 WAA291 WAA292 WAA293	3 6 9 12	● ● ●		1-3 pole 4 pole
1 pole 2 pole 3 pole	L1200			WAA290 WAA291 WAA292	3 6 9	● ● ●		1-3 pole
1 pole 2 pole 3 pole	L1600			WAA290 WAA291 WAA292	4 8 12	● ● ●		1-3 pole
1 pole 2 pole	L2000			WAA290 WAA291	5 10	● ●		1- und 2 pole

[< back to table of contents >](#)

● Additional length for switches size S2 for mounting E/EF = 27 mm  
 ● Additional length for switches size S3 for mounting E/EF = 31,5 mm and mounting ER/VE = 20,1 mm

Function/Type	Escutch. Plate	Handle	Code	Stages	Double Latching	Connection Diagram	L350 L630 L1000	L351 L631
---------------	----------------	--------	------	--------	-----------------	--------------------	-----------------------	--------------

## Double-throw Switches without „OFF“ 60° Switching Dimensions p.56

1 pole 2 pole 3 pole 4 pole	L350			WAA220 WAA221 WAA222 WAA223	2 4 6 8			1-4 pole
1 pole 2 pole 3 pole 4 pole	L351			WAA220 WAA221 WAA222 WAA223	2 4 6 8			1-4 pole
1 pole 2 pole 3 pole 4 pole	L400			WAA220 WAA221 WAA222 WAA223	2 4 6 8			1-4 pole
1 pole 2 pole 3 pole 4 pole	L600			WAA220 WAA221 WAA222 WAA223	3 6 9 12	● ●		1-4 pole
1 pole 2 pole 3 pole	L630			WAA220 WAA221 WAA222	4 8 12	●		1-3 pole
1 pole 2 pole 3 pole	L631			WAA220 WAA221 WAA222	4 8 12	●		1-3 pole
1 pole 2 pole 3 pole	L800			WAA220 WAA221 WAA222	4 8 12	●		1-3 pole
1 pole 2 pole	L1000			WAA220 WAA221	6 12	●		1 and 2 pole
1 pole	L1200			WAA220	6			
1 pole	L1600			WAA220	8			
1 pole	L2000			WAA220	10			

[< back to table of contents >](#)

# Switch Function and Configuration

# L Switches

Function/Type	Escutch. Plate	Handle	Code	Stages	Double Latching	Connection Diagram	L350 L630 L1000	L351 L631
---------------	----------------	--------	------	--------	-----------------	--------------------	-----------------------	--------------

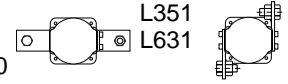

## Double-throw Switches with Center „OFF“ 60° Switching Dimensions p.56

1 pole 2 pole 3 pole 4 pole	L350			WAA210 WAA211 WAA212 WAA213	2 4 6 8			1-4 pole
1 pole 2 pole 3 pole 4 pole	L351			WAA210 WAA211 WAA212 WAA213	2 4 6 8			1-4 pole
1 pole 2 pole 3 pole 4 pole	L400			WAA210 WAA211 WAA212 WAA213	2 4 6 8			1-4 pole
1 pole 2 pole 3 pole 4 pole	L600			WAA210 WAA211 WAA212 WAA213	3 6 9 12	● ●		1-4 pole
1 pole 2 pole 3 pole	L630			WAA210 WAA211 WAA212	4 8 12	●		1-3 pole
1 pole 2 pole 3 pole	L631			WAA210 WAA211 WAA212	4 8 12	●		1-3 pole
1 pole 2 pole 3 pole	L800			WAA210 WAA211 WAA212	4 8 12	●		1-3 pole
1 pole 2 pole	L1000			WAA210 WAA211	6 12	●		1 and 2 pole
1 pole	L1200			WAA210	6			
1 pole	L1600			WAA210	8			
1 pole	L2000			WAA210	10			

[< back to table of contents >](#)

● Additional length for switches size S2 for mounting E/EF = 27 mm  
 ● Additional length for switches size S3 for mounting E/EF = 31,5 mm and mounting ER/VE = 20,1 mm

Function/Type	Escutch. Plate	Handle	Code	Stages	Double Latching	Connection Diagram	L350 L630 L1000	L351 L631
---------------	----------------	--------	------	--------	-----------------	--------------------	-----------------------	--------------

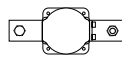

Multi-step Switches single pole without „OFF“

[Dimensions p.56](#)

3 Step	L350			WAA230	4		
3 Step	L351			WAA230	4		
3 Step	L400			WAA230	4		
4 Step	L350			WAA231	4		
4 Step	L351			WAA231	4		
4 Step	L400			WAA231	4		
5 Step	L350			WAA232	6		
5 Step	L351			WAA232	6		
5 Step	L400			WAA232	6		
6 Step	L350			WAA233	6		
6 Step	L351			WAA233	6		

[< back to table of contents >](#)

Function/Type	Escutch. Plate	Handle	Code	Stages	Double Latching	Connection Diagram	L350 L630 L1000	L351 L631
---------------	----------------	--------	------	--------	-----------------	--------------------	-----------------------	--------------

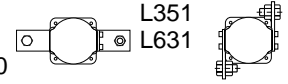

Multi-step Switches single pole without „OFF“

[Dimensions p.56](#)

6 Step	L400			WAA233	6		
7 Step	L350			WAA234	8		
7 Step	L351			WAA234	8		
7 Step	L400			WAA234	8		
8 Step	L350			WAA235	8		
8 Step	L351			WAA235	8		
8 Step	L400			WAA235	8		
9 Step	L350			WAA236	10		
9 Step	L351			WAA236	10		
9 Step	L400			WAA236	10		
10 Step	L350			WAA237	10		

[< back to table of contents >](#)

























# Switch Function and Configuration

# L Switches

Function/Type	Escutch. Plate	Handle	Code	Stages	Double Latching	Connection Diagram	L350 L630 L1000	L351 L631
---------------	----------------	--------	------	--------	-----------------	--------------------	-----------------------	--------------

## Multi-step Switches single pole without „OFF“

[Dimensions p.56](#)

10 Step	L351			WAA237	10		
10 Step	L400			WAA237	10		
11 Step	L350			WAA238	12		
11 Step	L351			WAA238	12		
11 Step	L400			WAA238	12		
12 Step	L350			WAA239	12		
12 Step	L351			WAA239	12		
12 Step	L400			WAA239	12		

[< back to table of contents >](#)





Two Hole Panel Mount or Mosaic Mount	Terminals rotated 90°	<b>Code</b>	CA4 CA4-1 CAD4-1
--------------------------------------	-----------------------	-------------	------------------------

[< back to table of contents >](#)

Panel Mount				
	Two hole, Protection IP 40	●	E E-V	● ●
	Two hole Protection IP 66/67/69k	●	EF EF-V	● ●
	Two hole with shaft for radio knobs, Protection IP 40 Shaft diam. 6 mm/.24 inch		E9	●
	Shaft diam. 6.35 mm/.25 inch, Protection IP 40		E91	●
Mosaic Mount				
	For Siemens-Mosaic 30 mm grid depth, Protection IP 40		E92	●
	For Subklew-, Kreutzenbeck-, Symo-Mosaic, Protection IP 40 28 mm    25 mm    25 mm grid depth		E93	●
	For Mauell-Mosaic 30 mm grid depth, Protection IP 40		E94	●

Two or Four Hole Panel Mount	Terminals rotated 90°	Code	CAD., CA10-CA25	CA10B-CA63 C42	C43 C80-C200-4 L350 Size S2	C315 L400-L2000 Size S3
------------------------------	-----------------------	------	-----------------	----------------	-----------------------------	-------------------------

		Code				
<p><b>Panel Mount</b></p>  <p>Four hole, Protection IP 40</p> <p>Four hole, Protection IP 66/67/69k</p> <p>Two hole, Protection IP 66/69k</p>	<p>●</p> <p>●</p> <p>●</p>	<p>E E-V</p> <p>EF EF-V</p> <p>E22 E22-V</p>	<p>●</p> <p>●</p> <p>●</p>	<p>●</p> <p>●</p> <p>●</p>	<p>●</p> <p>●</p> <p>●</p>	<p>●</p> <p>●</p> <p>●</p>
<p><b>Panel mount using larger face plate, handle and heavy duty stop</b></p>  <p>Four hole, Protection IP 40</p> <p>Four hole, Protection IP 66/67/69k</p>		<p>EG</p> <p>EGF</p>	<p>●</p> <p>●</p>	<p>CA40-CA63</p> <p>CA40-CA63</p>	<p>C80-C200-4</p> <p>C80-C200-4</p>	
<p><b>Double End Mount</b></p>  <p>Four hole, Protection IP 40</p> <p>Four hole, Protection IP 66/67/69k</p>		<p>ER</p> <p>ERF</p>	<p>●</p> <p>●</p>	<p>CAD., CA10-CA25</p> <p>CAD., CA10-CA25</p>	<p>●</p> <p>●</p>	<p>●</p> <p>●</p>

< back to table of contents >

<b>Two or Four Hole Panel Mount</b>	<b>Code</b>	CAD.. CA10- CA25	CA10B CA11B CA20B CA25B	C32 C42 CA40 CA50 CA63	C43
-------------------------------------	-------------	------------------------	----------------------------------	------------------------------------	-----

[< back to table of contents >](#)

	<p><b>Panel mount with heavy duty latching and metal shaft</b></p> <p>Four hole, Protection IP 40 48 x 48 Plate – S0</p>	KN2	●			
	<p>Four hole, Protection IP 40 64 x 64 Plate – S1</p>	KN1	●	●	●	
	<p>Four hole, Protection IP 40 64 x 64 Plate – S1 complete with 6mm square metal shaft</p>	KD1	●	●	●	
	<p><b>Panel mount with protective cover</b></p>					
	<p>Four hole Protection front IP 40 rear IP 30</p>	EC	CAD.. CA10- CA25	●		
	<p>Four hole with additional shaft seal Protection front IP 65 rear IP 30</p>	ED	CAD.. CA10- CA25	●		
	<p>Four hole Protection front IP 40 rear IP 42</p>	EC1		●		
	<p>Four hole with additional shaft seal Protection front IP 65 rear IP 42</p>	ED1		●		
	<p>Two hole Protection front IP 66/69k rear IP 42</p>	ED22	CAD.. CA10- CA25			

Single Hole Mount	Terminals rotated 90°	Code	CA4 CA4-1 CAD4-1	CAD.. CA10- CA25
-------------------	-----------------------	------	------------------------	------------------------

		Code	mm	mm
	<p><b>Single Hole Mount complete with lock nut and shaft seal</b> Bezel mount, Protection IP 66/67/69k</p>	<ul style="list-style-type: none"> <li>● FS1</li> <li>● FS1-V</li> <li>● FT1</li> <li>● FT1-V</li> <li>● FT3</li> <li>● FT3-V</li> </ul>	<p>16/22 16/22</p>	<p>22 22 22/30 22/30</p>
	<p>Square face plate, Protection IP 66/67/69k</p>	<ul style="list-style-type: none"> <li>● FS2</li> <li>● FS2-V</li> <li>● FT2</li> <li>● FT2-V</li> <li>● FT4</li> <li>● FT4-V</li> </ul>	<p>16/22 16/22</p>	<p>22 22 22/30 22/30</p>
	<p>S1 square face plate and heavy duty stop, Protection IP 66/67/69k</p>	<ul style="list-style-type: none"> <li>● FH3</li> <li>● FH3-V</li> </ul>		<p>22 22</p>
	<p>Rectangular face plate, Protection IP 66/67/69k</p>	<ul style="list-style-type: none"> <li>● FS4</li> <li>● FS4-V</li> <li>● FT6</li> <li>● FT6-V</li> </ul>	<p>16/22 16/22</p>	<p>22 22</p>
	<p>S1 rectangular face plate and heavy duty stop, Protection IP 66/67/69k</p>	<ul style="list-style-type: none"> <li>● FH4</li> <li>● FH4-V</li> </ul>		<p>22 22</p>
	<p>Lock nut spanner</p>	<p>S00T170 09</p>		

[< back to table of contents >](#)

Base Mount	Terminals rotated 90°	Code	CAD.. CA10- CA25	CA10B- CA63 C42	C43 C80- L2000
------------	-----------------------	------	------------------------	-----------------------	----------------------

**Base Mount**



Four hole, Protection IP 40

Four hole with integrated simplified door clutch, Protection IP 65



Two hole, Protection IP 40

Two hole with integrated simplified door clutch, Protection IP 65



Snap-on for DIN Rail EN 60715, Protection IP 40

●	VE VE-V	CAD.. CA10- CA25	● ●	●
●	VF VF-V	CAD.. CA10- CA25		
●	VE22 VE22V	CAD.. CA10- CA25	●	
●	VF22 VF22V	CAD.. CA10- CA25	●	
	VE1		●	●

<b>Base Mount</b>	<b>Code</b>	CA4 CA4-1 CAD4-1	CAD.. CA10- CA25
-------------------	-------------	------------------------	------------------------

**DIN Rail Mount**



Snap-on for DIN Rail EN 60715 with face plate for 45 mm standard knock-out.

VE2



Snap-on for DIN Rail EN 60715. With face plate for 45 mm standard knock-out. The handle and plate are adjustable in height.

VE21





CAD..  
CA10-  
CA20

VE21V

CA25

[< back to table of contents >](#)

<p><b>Mounting Plates for Plaster Depth Boxes acc. to DIN 49073 and ÖNORM E8608</b></p>	<p><b>Code</b></p>	<p>CAD.. CA10- CA25</p>
---	--------------------	---------------------------------

	<p>Plaster depth trim, Protection IP 40</p>	<p>UE1</p>	<p>●</p>
	<p>With light, Protection IP 40</p>	<p>UE2</p>	<p>●</p>
	<p>With facility for light addition, Protection IP 40</p>	<p>UE3</p>	<p>●</p>

< back to table of contents >

# Face plates



Square and rectangular face plates are available for each size of switch. The face plate consists of a frame and a faceplate having the switch positions which is then embossed with hot-foil backing. The face plate frame is an essential part of the switch and serves as a bearing surface for the handle. If the switch is to be mounted without an face plate we would recommend for size S1, S2 and S3 the handle bearing plate T100-04.

## Standard Letterings Available

(Over 500 standard letterings, special letterings upon request.)

### 30° switching

F022	F141	F158	F703	F023	F137	F142	F159	F701	F704	F152	F709	F026	F035	F153	F169	F024	F143
F160	F221	F222	F224	F025	F034	F036	F037	F038	F039	F139	F144	F147	F149	F150	F151	F219	F258
F259	F273	F280	F329	F384	F708	F053	F161	F297	F298	F306	F307	F001	F040	F052	F229	F355	F018
F019	F029	F030	F154	F155	F165	F166	F183	F184	F301	F302	F321	F332	F333	F334	F335	F374	F711
F712	F002	F021	F033	F041	F055	F305	F319	F054	F003	F042	F138	F255	F299	F308	F353	F350	F351
F004	F014	F017	F020	F027	F028	F031	F032	F043	F049	F135	F156	F157	F162	F167	F168	F187	F189
F303	F304	F336	F337	F347	F348	F710	F713	F714	F734	F005	F044	F136	F140	F702	F006	F010	F045
F015	F050	F007	F011	F046	F008	F012	F047	F016	F051	F009	F013	F048	F748				

### 45° switching

F747	F295	F742	F743	F215	F216	F738	F744	F746	F792	F793	F107	F109	F114	F115	F212	F213	F214
F217	F267	F289	F330	F375	F376	F383	F408	F409	F410	F411	F412	F413	F426	F427	F430	F729	F752
F775	F776	F777	F778	F779	F780	F781	F796	F797	F798	F105	F108	F112	F113	F117	F118	F293	F429
F739	F741	F419	F789	F790	F791	F794	F795	F110	F106	F116	F294	F317	F414	F415	F416	F417	F418
F782	F783	F784	F785	F786	F787	F788	F799	F111	F210	F211	F284	F285	F296	F322	F727	F740	

[< back to table of contents >](#)



# Face plates

## 60° switching

F070	F087	F088	F089	F133	F197	F198	F232	F243	F247	F263	F268	F310	F311	F323	F328	F352	F367
F379	F380	F470	F754	F072	F163	F164	F192	F193	F196	F230	F231	F234	F244	F257	F262	F264	F282
F288	F291	F313	F382	F441	F705	F721	F722	F750	F757	F758	F075	F076	F098	F220	F223	F356	F357
F377	F723	F071	F073	F080	F081	F085	F086	F090	F091	F092	F093	F094	F104	F194	F235	F237	F239
F240	F241	F249	F260	F269	F274	F281	F290	F292	F312	F314	F315	F316	F324	F331	F344	F354	F358
F359	F364	F370	F371	F373	F381	F385	F442	F444	F469	F732	F735	F759	F077	F100	F101	F102	F309
F342	F343	F361	F362	F363	F365	F366	F078	F191	F325	F326	F720	F074	F082	F096	F097	F195	F724
F256	F079	F083	F084	F095	F099	F185	F190	F199	F233	F236	F238	F242	F283	F725	F730	F731	F736
F737																	

[< back to table of contents >](#)

## 90° switching

F056	F063	F068	F134	F201	F251	F252	F346	F456	F058	F065	F069	F177	F178	F182	F208	F253	F254
F340	F360	F378	F458	F443	F700	F743	F057	F061	F064	F067	F171	F181	F205	F207	F209	F320	F349
F437	F445	F715	F719	F059	F060	F062	F066	F170	F172	F173	F174	F175	F176	F179	F180	F186	F188
F202	F204	F206	F250	F265	F266	F286	F318	F327	F338	F339	F425	F716	F717	F718	F726	F733	F751
F752	F756																

## Miscellaneous





F119	F130	F122	F126	F125	F129	F225	F248	F261	F341	F345	F287	F123	F127	F145	F146	F148	F706						
F707	F245	F120	F124	F128	F131	F121	F132	F749										F990	F991	F801	F802	F803	F804
F805	F806	F807	F808	F809	F810	F811	F812	F813	F814	F815	F816	F817	F818	F819	F820	F821	F822						
F823	F824	F825	F826	F827	F828	F829	F830	F831	F832	F833	F834	F835	F837	F838	F839	F840	F841						

<sup>1</sup>INTERRUPTEUR PRINCIPAL, OUVERTURE EN POSITION 0 <sup>2</sup>INTERRUPTORE GENERALE, APRIRE SOLO CON MANIGLIA SU 0  
<sup>3</sup>INTERRUPTOR PRINCIPAL, ABRIR ARMARIO SOLO EN POS. "0"

# Handles

Type	Color	Code	Size S00 S0 S1 S2 S3
------	-------	------	-------------------------











Type	Color	Code	Size S00 S0 S1 S2 S3
------	-------	------	-------------------------

<p>R-Handle</p> 	black red	G001 G002	— ● ● ● ● — ● ● ● ●
<p>F-Handle</p> 	black red	G221 G222	● ● ● ● — ● ● ● ● —
<p>S-Handle</p>  <p>S0 S1</p>	black red	G301 G302	— ● ● — — — ● ● — —
<p>P-Handle</p>  <p>S0 S1-S3</p>	black red	G211 G212	— ● ● ● ● — ● ● ● ●
<p>Handwheel</p> 	black	G971	— — — — ●

<p>I-Handle</p>  <p>S00 S0-S3</p>	black red	G251 G252	● ● ● ● ● ● ● ● ● ●
<p>B-Handle</p> 	black red	G521 G522	— ● ● — — — ● ● — —
<p>L-Handle</p> 	black red	G501 G502	— — ● — — — — ● — —
<p>K-Handle</p> 	black red	G411 G412	— — ● ● ● — — ● ● ●
<p>O-Handle</p> 	black red	G321 G322	— — ● — — — — ● — —

[< back to table of contents >](#)

## International Standards and Approvals

Country	Authority	Mark or Standard	CAD11/12	CA10	CA10B		C26	CA40	C43		L350/1	L400	L1200
			CA4	CA11	CA11B	CA25	C32	CA50	C80	C315	L630/1	L600	L1600
			CA4-1	CA20	CA20B	CA25B	C42	CA63	C125	C316	L1000	L800	L2000
USA	Underwriters Laboratories Inc.	 <sup>1</sup>									●	●	●
		 <sup>2,3</sup>	●	●	●	●	●	●	●			●	
Canada	UL investigated acc. to CSA	 <sup>5</sup>	●	●	●	●	●		●		●	●	●
		 <sup>1</sup>									●	●	●
		 <sup>2,3</sup>	●	●	●	●	●	●	●	●			●
International Electrical Commission (IEC) Recommendation		IEC 60947 <sup>4</sup>	+	+	+		+	+	+		+	+	+
China	China Quality Certification Centre	 GB/T14048.3	●	●	●		●		●		●		
			●	●	●	●	●	●	●		●	●	●
Russia Belarus Kazakhstan	Eurasian Conformity		●	●	●	●	●	●	●		●	●	●
Russian Federation	Russian Maritime Register of Shipping		●	●	●	●							
Lloyds Register EMEA			●	●	●								

● Switch approved      + Switch conforms to requirements

<sup>1</sup>Approved under the "Component Program" (UL-Recognized Industrial Component). File No. E35541, Category Control No. NLRV2 (U.S.) and NLRV8 (Canada) resp. File No. E60262, Category Control Number NRNT2 (U.S.) and NRNT8 (Canada).

<sup>2</sup>Approved under the "Listing Program". File No. E35541, Category Control No. NLRV (U.S.) resp. NLRV7 (Canada).

<sup>3</sup>Switch types CAD11/CAD12 approved under the "Listing Program". File No. E60262, Category Control No. NRNT (U.S.) resp. NRNT7 (Canada).

<sup>4</sup>IEC does not operate an approval scheme.

<sup>5</sup>File No. 13002ass No. 3211-05 resp. 4652-04.

<b>Selection Data</b>	CA4 CA10 CA11 CA20 CA25 C42 C315
	CA4-1 CA10B CA11B CA20B CA25B C26 C32 C43 CA40 CA50 CA63 C80 C125 C200-4 C316

<b>Rated Insulation Voltage <math>U_i</math></b>	IEC 60947-3, EN 60947-3 <sup>1</sup>	V	440	690	690	690	690	690	690	690	690	690	690	690	690	690	690	1000
	VDE 0660 part 107 <sup>1</sup>	V	380	660	660	660	690	660	660	660	690	690	690	660	660	–	660	
	SEV <sup>4</sup>	V	300	300	600	600	300	600	600	600	600	600	600	600	600	–	600	
	UL/Canada	V	300	300	600	600	300	600	600	600	600	600	600	600	600	–	600	
	CEE/NEMKO min. voltage	V	400/380	380	400	400	–	400	400	400	–	–	–	400	–	–	–	
			on request															
<b>Rated Impulse Withstand Voltage <math>U_{imp}</math></b>		kV	4	6	6	6	6	6	6	6	6	6	6	6	6	6	6	6/8
<b>Rated Thermal Current <math>I_U/I_{th}</math></b>	IEC 60947-3, EN 60947-3	A	10	20	20	25	32	32	50	63	40	50	63	115	150	200	315	
	VDE 0660 part 107	A	10	20	20	25	32	32	50	63	40	50	63	115	150	200	315	
	SEV <sup>3</sup> 380 V	A	10	16	16	25	32	32	40	63	40	50	63	100	150	–	315	
	660 V	A	–	12	12	25	32	32	40	63	40	50	63	–	–	–	315	
UL/Canada	A	10	20	20	30	30	40	50	65	45	55	65	100	150	–	240		
<b>Rated Operational Current <math>I_e</math></b>																		
AC-21A Switching of resistive loads, including moderate overloads	IEC 60947-3, EN 60947-3	A	10	20	20	25	32	32	40	63	40	50	63	100	150	200	315	
	VDE 0660 part 107	A	10	20	20	25	32	32	40	63	40	50	63	100	150	200	315	
AC-1 Resistive or low inductive loads	SEV <sup>4</sup> 380 V	A	10	16	16	25	32	32	40	63	40	50	63	100	150	–	315	
	660 V	A	–	12	12	20	32	32	40	63	40	50	63	–	–	–	315	
AC-22A Switching of combined resistive or low inductive loads including moderate overloads	IEC 60947-3, EN 60947-3	A	10	20	20	25	32	32	40	63	40	50	63	100	150	150	315	
	VDE 0660 220 V-500 V	A	10	20	20	25	32	32	40	63	40	50	63	100	150	150	315	
	part 107 660 V-690 V	A	–	20	20	25	32	32	40	63	40	50	63	100	125	125	125	
AC-15 Switching of control devices, contactors, valves etc.	IEC 60947-5-1, EN 60947-5-1	A	2,5	5	5	8	12	14	16	–	14	16	16	–	–	–	–	
	VDE 0660 220 V-240 V	A	1,5	4	4	5	6	6	7	–	6	7	7	–	–	–	–	
	part 200 380 V-440 V	A	1,5	4	4	5	6	6	7	–	6	7	7	–	–	–	–	
Pilot Duty	UL/Canada <sup>3</sup> Heavy	VAC	A300	A300	A600	A600	A300	A600	A600	A600	A600	A600	A600	–	–	–	A600	
Ampere Rating Resistive or low inductive loads	UL/Canada <sup>3</sup>	A	10	20	20	30	30	40	50	65	45	55	60	100	150	–	240	
Resistive load/motor load	CEE NEMKO	A	4/2	10/6	10/6	16/10	–	25/10	32/10	40/10	–	–	–	63/10	–	–	–	
		A	6/4 <sup>2</sup>	10/6	–	20/10	–	–	–	–	–	–	–	–	–	–	–	
<b>Breaking capacity</b>	220 V-240 V	A	50	150	150	200	280	280	380	550	290	330	440	860	1100	1100	2000	
	380 V-440 V	A	50	150	150	200	250	250	360	550	290	330	440	860	1100	1100	2000	
	660 V-690 V	A	–	80	80	125	150	150	270	365	170	200	260	400	490	490	340	
Power loss per contact at $I_U$		W	0,4/0,9	0,9	0,9	0,9	0,7	1,3	1,3	1,7	1	1,8	2,8	5,8	3,8	6,7	17	
Resistance to vibration			min. 4 g, 2-100 Hz, 1,6 mm									on request						
Resistance to shock			min. 5 g, 6 ms									min. 5 g, 30 ms						
<b>Short Circuit Protection</b>																		
Max. fuse size (gG-characteristic)		A	10	25	25	35	35	50	63	80	50	63	63	125	200	200	315	
Rated short-time withstand current (1s-current)		A	60	140	140	280	480	350	800	1000	950	950	950	1300	2000	2000	4200	
<b>Min. Ambient Temperature of Stages</b>			-25 °C (valid only without optional extra, C315/C316 on request)															
<b>Max. Ambient Temperature of Stages</b> <sup>5,7</sup> open at 100 % $I_U/I_{th}$			55 °C during 24 hours with peaks up to 60 °C															
enclosed at 100 % $I_{the}$			35 °C during 24 hours with peaks up to 40 °C															

[< back to table of contents >](#)

44 <sup>1</sup>Valid for lines with grounded common neutral termination, overvoltage category III, pollution degree 3. Values for other supply systems on request. <sup>2</sup>Valid for CA4 only. <sup>3</sup>International Standards and Approvals, refer to page 43. <sup>4</sup>For electromagnetic optional extras see additional data in Catalog 101. <sup>5</sup>Storage temperature: -40 °C to 85 °C (in case of temperature below -5 °C no shock load permissible).

<b>Selection Data</b>	CA4 CA10 CA11 CA20 CA25 C42 C315
	CA4-1 CA10B CA11B CA20B CA25B C26 C32 C43 CA40 CA50 CA63 C80 C125 C200-4 C316

[< back to table of contents >](#)

Rated Utilization Category		IEC 60947-3, EN 60947-3 VDE 0660 part 107																		
AC-2	Slip ring motor starting, reversing and plugging, star-delta starting CA4-CA50	3 phase	220 V-240 V	kW	2,5	4	4	5,5	7,5	8	10	18,5	10	11	18,5	30	37	37	55	
		3 pole	380 V-440 V		4,5	7,5	7,5	11	15	15	18,5	30	18,5	22	30	40	55	75	75	110
			500 V		-	10	10	15	18,5	18,5	22	40	22	30	40	55	75	75	110	
			660 V-690 V		-	10	10	13	15	15	22	37	22	30	37	55	55	55	55	
AC-3	Direct-on-line starting, star-delta starting CA63-C315	3 phase	220 V-240 V	kW	1,5	3	3	4	5,5	5,5	7,5	11	7,5	11	11	15	22	22	37	
		3 pole	380 V-440 V		2,2	5,5	5,5	7,5	11	11	15	18,5	15	18,5	18,5	30	37	37	55	
			500 V		-	5,5	5,5	7,5	11	11	15	18,5	15	18,5	18,5	30	37	37	55	
			660 V-690 V	-	5,5	5,5	7,5	11	11	15	18,5	15	18,5	22	30	30	30	37		
		1 phase	110 V-120 V	kW	0,3	0,6	0,6	1,5	2,2	2,2	2,5	3	2,5	3	3	3,7	5,5	5,5	11	
2 pole	220 V-240 V		0,55	2,2	2,2	3	4	4	5,5	6	5,5	6	6	7,5	11	11	22			
			380 V-440 V		0,75	3	3	3,7	5,5	5,5	7,5	11	7,5	11	11	13	18,5	18,5	30	
AC-4	Direct-on-line starting, reversing, plugging and inching	3 phase	220 V-240 V	kW	0,37	0,55	0,55	1,5	2,5	2,7	3,7	5,5	3,7	4	5,5	6	10	10	15	
		3 pole	380 V-440 V		0,55	1,5	1,5	3	5,5	5,5	6	7,5	6	7	7,5	11	15	15	25	
			500 V		-	1,5	1,5	3	5,5	5,5	6	7,5	6	7	7,5	11	15	15	25	
			660 V-690 V	-	1,5	1,5	3	5,5	5,5	6	7,5	6	7,5	9	11	15	15	22		
		1 phase	110 V-120 V	kW	0,15	0,3	0,3	0,45	0,75	0,75	1,1	1,2	1,1	1,2	1,2	1,2	1,5	2,2	2,2	4
2 pole	220 V-240 V		0,25	0,75	0,75	1,1	1,5	1,5	2,2	2,4	2,2	2,4	2,4	3	4	4	7,5			
			380 V-440 V		0,5	1,5	1,5	2,2	3	3	3,7	4	3,7	4	4	5,5	7,5	7,5	11	
AC-23A	Frequent switching of motors or other high inductive loads	3 phase	220 V-240 V	kW	1,8	3,7	3,7	5,5	7,5	7,5	11	15	7,5	11	15	30	37	37	75	
		3 pole	380 V-440 V		3	7,5	7,5	11	15	15	22	30	18,5	22	30	45	75	75	132	
			500 V		-	7,5	7,5	11	15	15	30	45	18,5	22	30	55	90	90	132	
			660 V-690 V	-	7,5	7,5	11	15	15	22	40	18,5	22	30	45	55	55	37		
		1 phase	110 V-120 V	kW	0,37	0,75	0,75	1,5	2,2	2,2	2,5	4	2,2	2,5	4	5,5	11	11	18,5	
2 pole	220 V-240 V		0,75	2,5	2,5	3	4	4	5,5	10	4	5,5	10	15	22	22	37			
			380 V-440 V		1,1	3,7	3,7	5,5	7,5	7,5	11	18,5	7,5	11	18,5	22	37	37	55	
<b>Ratings</b>		UL/Canada																		
	Standard motor load DOL-Rating (similar AC-3)	3 phase	110 V-120 V	HP	0,75	1,5	1,5	3	5	5	7,5	7,5	7,5	7,5	7,5	10	15	-	30	
		3 pole	220 V-240 V		1	3	3	7,5	10	10	15	15	15	15	20	25	-	75		
			440 V-480 V		-	-	5	10	-	20	25	25	25	25	30	40	-	75		
			550 V-600 V	-	-	5	10	-	25	30	30	25	30	30	40	50	-	60		
		1 phase	110 V-120 V	HP	0,33	0,5	0,5	1,5	2	2	3	3	3	3	3	5	7,5	-	15	
2 pole	220 V-240 V		0,75	1	1	3	5	5	7,5	7,5	7,5	7,5	10	15	-	40				
	277 V		0,75	2	2	3	5	5	7,5	7,5	7,5	7,5	10	15	-	40				
	440 V-480 V		-	-	2	5	-	10	15	15	15	15	15	20	25	-	50			
	550 V-600 V		-	-	2	5	-	15	20	20	15	20	20	25	30	-	50			
	Heavy motor load Reversing-Rating (similar AC-4)	3 phase	110 V-120 V	HP	-	0,5	0,5	1	2	2	3	5	-	-	-	7,5	10	-	15	
		3 pole	220 V-240 V		-	1	1	2	3	3	5	7,5	-	-	-	15	20	-	30	
			440 V-600 V		-	-	3	5	-	10	15	20	-	-	-	25	30	-	40	
		1 phase	110 V-120 V	HP	-	0,17	0,17	0,33	1,5	1,5	1,5	2	-	-	-	3	5	-	7,5	
		2 pole	220 V-240 V		-	0,5	0,5	0,75	3	3	3	5	-	-	-	7,5	10	-	15	
	277 V		-	0,6	0,6	1	3	3	3	5	-	-	-	7,5	10	-	15			

<b>Selection Data</b>	CA4 CA10 CA11 CA20 CA25 C42 C315
	CA4-1 CA10B CA11B CA20B CA25B C26 C32 C43 CA40 CA50 CA63 C80 C125 C200-4 C316

<b>Max. Permissible Wire Gage</b> - Use copper wire only																		
Single-core or stranded wire	mm <sup>2</sup>	2x 1,5	2x 2,5	2x 2,5	2x 4	2x 6	2x 6	2x 10	2x 16	16 16	16 16	35 70	95 <sup>1</sup>	185 <sup>1</sup>				
	AWG	14	12	12	10	8	8	8	6	6	6	2	2/0	-	MCM 350			
Flexible wire (sleeving in accordance with DIN 46228) Flexible AWG wires (without sleeve)	mm <sup>2</sup>	2x 1,5	2x 2,5	2x 2,5	2x 4	2x 4	2x 6	2x 6	2x 10	2x 10	2x 10	2x 10	2x 25	2x 50	95 <sup>1</sup>	150 <sup>1</sup>		
	AWG	(1) 16	(2,5) 14	(2,5) 14	(2,5) 12	(4) 10	(4) 10	(6) 8	(10) 6	(10) 6	(10) 6	(10) 6	(25) 3	(50) 1/0	-	MCM 300		
<b>Tightening torque of screws</b>																		
	Nm	0,4	0,6	0,6	1,3	1,3	1,3	2,2	3	1,8	1,8	1,8	4	4,5	8	14		
	lb-in	3,5	5	5	12	12	12	19,5	26,4	16	16	16	35	39,8	70	125		
<b>DC Switching Capacity<sup>2</sup></b>																		
contacts in series::	1	2	3	4	5	6	8	<b>Rated Thermal Current I<sub>e</sub></b>										
	Permissible voltage in volts							CA4	CA10	CA10S	CA20	CA20S	CA25	CA25S	CA40	CA40S	CA63S	
<b>Utilization category DC-21A</b>	24	48	72	96	120	144	192	A	10	16	16	21	24	26	32	35	40	63
Switching of resistive load	48	96	144	192	240	288	384	A	6	14	15	18	24	25	32	32	40	63
Time constant L/R≤1ms	60	120	180	240	300	360	480	A	5	13	15	17	21	24	28	28	40	50
	110	220	330	440	550	660	-	A	4	6	7	6	7	7	9,3	-	-	-
	220	440	660	-	-	-	-	A	0,8	0,9	1	1	1	1	1	-	-	-
<b>Utilization category DC-22A</b>	24	48	72	96	120	144	192	A	8	14	15	18	24	25	32	35	40	63
Switching of mixed resistive and inductive load	48	96	144	192	240	288	384	A	5	13	15	17	24	25	32	32	40	63
f.e. shunt motors	60	120	180	240	300	360	480	A	4	12	15	16	19	24	25	-	20	25
time constant L/R≤2,5ms	110	220	330	440	550	660	-	A	1,5	1,9	2	2	2	2,25	3	-	-	-
	220	440	660	-	-	-	-	A	0,3	0,3	0,35	0,3	0,35	0,35	0,35	-	-	-
<b>Utilization category DC-23A</b>	24	48	72	96	120	144	192	A	7	13	15	16	23	23	32	35	40	63
Switching of highly inductive loads	48	96	144	192	240	288	384	A	4	12	15	15	23	21	32	26	40	63
f.e. series motors	60	120	180	240	300	360	480	A	3,5	10	13	14	16	18	25	-	-	-
Zeitkonstante L/R≤15ms	110	220	330	440	550	660	-	A	1	1,5	1,75	1,7	1,75	2	2,5	-	-	-
	220	440	660	-	-	-	-	A	0,2	0,2	0,3	0,2	0,3	0,2	0,3	-	-	-
<b>Utilization category DC-13</b>	24	48	-	-	-	-	-	A	0,8	3	-	4	-	5	-	-	-	-
Control of electromagnets	48	96	-	-	-	-	-	A	0,5	1,7	-	2,4	-	3	-	-	-	-
Time constant L/R≤100ms	60	120	-	-	-	-	-	A	0,2	1,4	-	1,8	-	2,5	-	-	-	-
	110	220	-	-	-	-	-	A	-	0,7	-	1	-	1,5	-	-	-	-
	220	440	-	-	-	-	-	A	-	0,15	-	0,35	-	0,5	-	-	-	-

<sup>1</sup>Cable lug must accept M8 (C200-4) and M12 (C315/C316) screw. <sup>2</sup>Values for switches with spring return on request.

<b>Selection Data</b>	L350				L630							
	L351	L400	L600	L631	L800	L1000	L1200	L1600	L2000			

[< back to table of contents >](#)

<b>Rated Insulation Voltage U<sub>i</sub></b>	IEC 60947-3, EN 60947-3 <sup>1</sup> VDE 0660 part 107 <sup>1</sup>		V	690	690	690	690	690	690	690	690	690	
	UL/Canada <sup>2</sup>		V	600	600	600	600	600	600	600	600	600	
	min. voltage		V	on request									
<b>Rated Impulse Withstand Voltage U<sub>imp</sub></b>			kV	6	6	6	6	6	6	6	6	6	
<b>Rated Thermal Current I<sub>v</sub>/I<sub>th</sub></b>	IEC 60947-3, EN 60947-3 VDE 0660 part 107												
	Ambient temp. +35 °C during 24 hours with peaks up to +40 °C		A	350	500	800	630	1100	1000	1450	1900	2400	
	Ambient temp. +55 °C during 24 hours with peaks up to +60 °C		A	350	500	750	600	950	920	1300	1700	2000	
	UL/Canada <sup>2</sup>		A	350	400	630	630	800	1000	1200	1600	2000	
<b>Rated Operational Current I<sub>e</sub></b>													
AC-20A No-load operation	IEC 60947-3, EN 60947-3 VDE 0660 part 107		690 V	A	350	500	800	630	1100	1000	1450	1900	2400
	Occasional switching under load cos φ 0,8	3 phase, 3 pole	220 V-440 V	A	350	500	800	500	1000	630	1200	1200	1200
		and	500 V	A	350	450	500	450	630	500	800	800	800
	1 phase, 2 pole	660 V-690 V	A	315	350	400	360	400	400	400	400	400	
AC-21B Switching of resistive loads, including moderate overloads	3 phase, 3 pole		220 V-440 V	A	250	450	500	350	630	400	800	800	800
	and		500 V	A	250	400	450	315	500	350	630	630	630
	1 phase, 2 pole		660 V-690 V	A	200	300	350	250	350	300	350	350	350
Interrupting Rating	UL/Canada <sup>2</sup>		600 V	A	200	300	300	200	300	200	300	200	200
	CSA		600 V	A	200	200	200	200	200	200	200	200	200
<b>Rated Utilization Category</b>	IEC 60947-3, EN 60947-3 VDE 0660 part 107												
AC-23B Occasional switching of motors or other high inductive loads	3 phase		220 V-240 V	kW	45	75	75	45	75	45	75	75	75
	3 pole		380 V-440 V	kW	90	132	132	90	132	90	132	132	132
			500 V	kW	110	132	132	110	132	110	132	132	132
			660 V-690 V	kW	55	55	65	65	65	65	65	65	65
<b>Short Circuit Protection</b>													
Max. fuse size	(aR-characteristic)		A	400	500	800	630	1100	1000	2x800	2x1000	2x1250	
Rated short-time withstand current	(1s-current)		A	on request									
<b>Anschlussklemmen</b>													
	for connection screw length		mm	Cable lug or copper bus									
				M12	M12	M16	M16	M16	M16	M16	2xM16	4xM16	
				20	30	40	30	40	40	40	40	50	50
<b>Tightening torque of screws</b>													
			Nm	25	25	25	25	25	25	25	25	25	
			lb-in	220	220	220	220	220	220	220	220	220	
<b>Min. Ambient Temperature of Stages</b>				-5 °C (-25 °C on request)									
<b>Max. Ambient Temperature of Stages</b> <sup>3,4</sup>				55 °C during 24 hours with peaks up to 60 °C, permissible load see Rated Thermal Current.									

<sup>1</sup>Valid for lines with grounded common neutral termination, overvoltage category III, pollution degree 3. Values for other supply systems on request.  
<sup>2</sup>International Standards and Approvals, refer to page 43. <sup>3</sup>For electromagnetic optional extras see additional data in Catalog 101. <sup>4</sup>Storage temperature: -40 °C to 85 °C (in case of temperature below -5 °C no shock load permissible).

<b>Selection Data</b>	CAD4-1	CAD11	CAD12
-----------------------	--------	-------	-------

<b>Bemessungsisolationsspannung <math>U_i</math></b>	IEC 60947-3, EN 60947-3 <sup>1</sup> VDE 0660 part 107 SEV <sup>2</sup> North America min. voltage	V V V V	440 – 300 1 <sup>7</sup>	600 600 300 1	600 600 300 6
<b>Rated Impulse Withstand Voltage <math>U_{imp}</math></b>				on request	
<b>Rated Thermal Current <math>I_U/I_{th}</math></b>	IEC 60947-3, EN 60947-3 VDE 0660 part 107 SEV <sup>2</sup> Nordamerika	A A A	5 – 5	6 5 6	6 5 6
<b>Bemessungsbetriebsstrom <math>I_e</math></b>	IEC 60947-3, EN 60947-3 VDE 0660 part 107 North America <sup>3</sup>				
AC-21A	Switching of resistive loads, including moderate overloads	1 V/6 V 12 V/24 V 48 V/110 V 220 V/400 V 440 V/500 V 600 V	A A A A A A	5/2 1,2/0,7 0,45/0,25 0,15/– 0,1/– –	6/3 2/1 0,8/0,4 0,2/0,13 0,1/0,08 0,05
AC-1	Resistive or low inductive loads	SEV <sup>2</sup> 1 V/6 V 12 V/24 V 48 V/110 V 220 V/380 V 440 V/500 V 600 V	A A A A A A	– – – – – –	5/3 2/1 0,8/0,4 0,2/0,13 0,1/0,08 0,05
<b>Power loss per contact at <math>I_U</math></b>		W	0,4	0,5	0,2
<b>Short Circuit Protection</b>					
	Max. fuse size (gG-characteristic)	A	5	6	6
	Rated short-time withstand current (1s-current)	A	30	35	50
<b>DC Switching Capacity<sup>5</sup></b>	IEC 60947-3, EN 60947-3 VDE 0660 part 107 SEV <sup>2</sup> North America <sup>3</sup>				
DC-1	Resistive load T = 1 ms	1 V/6 V 12 V/24 V 48 V/60 V 110 V/220 V 240 V/500 V 600 V	A A A A A A	3/1,2 0,7/0,4 0,25/0,2 0,13/– 0,08/– –	4/2,5 1,5/0,8 0,3/0,27 0,2/0,1 0,08/0,03 0,02
<b>Max. Permissible Wire Gage</b> - Use copper wire only					
	Single-core or stranded wire	mm <sup>2</sup> AWG	2x 1,5 14	2x 2,5 12	2x 2,5 12
	Flexible wire (sleeving in accordance with DIN 46228) Flexible AWG wires (without sleeve)	mm <sup>2</sup> AWG	2x 1,5 (1) 16	2x 2,5 (2,5) 14	2x 2,5 (2,5) 14
<b>Tightening torque of screws</b>		Nm lb-in	0,4 3,5	0,6 5	0,6 5
<b>Min. Ambient Temperature of Stages</b> <b>Max. Ambient Temperature of Stages<sup>4, 6</sup></b>	open at 100 % $I_U/I_{th}$ enclosed at 100 % $I_{the}$		-25 °C (valid only without optional extra) 55 °C during 24 hours with peaks up to 60 °C 35 °C during 24 hours with peaks up to 40 °C		

[< back to table of contents >](#)

<sup>1</sup>Valid for lines with grounded common neutral termination, overvoltage category III, pollution degree 3. Values for other supply systems on request.  
<sup>2</sup>International Standards and Approvals, refer to page 43. <sup>3</sup>Max. 300 V. <sup>4</sup>For electromagnetic optional extras see additional data in Catalog 101.  
<sup>5</sup>Values for switches with spring return on request. <sup>6</sup>Storage temperature: -40 °C to 85 °C (in case of temperature below -5 °C no shock load permissible).  
<sup>7</sup>Values with lower voltages on request.



**Two or Four Hole Panel Mounting**

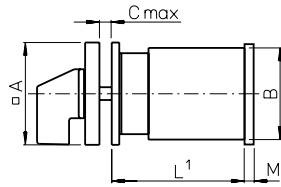

**E**  
for CA4, CA4-1,  
CAD4-1

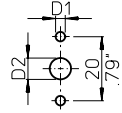

**E-V**  
for CA4, CA4-1,  
CAD4-1

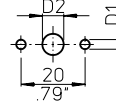

**E**  
**E-V**  
**ER**

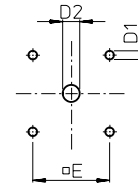

	CA10	CA4	CA11	CA20	CA25 <sup>3</sup>	CA20B	CA10B	CA11B	CA25B	C26	C32	C42 <sup>3</sup>	C43	CA40 <sup>3</sup>	CA50 <sup>3</sup>	CA63 <sup>3</sup>	C125	C200-4	L switches	L switches	
		CAD4-1	CAD12																Size S2	Size S3	
<b>A</b>	0	48	48	48	(64)	64	64	64	64	64	64	64	(88)	88	64	(88)	88	88	88	88	130
	1.18	1.89	1.89	1.89	(2.52)	2.52	2.52	2.52	2.52	2.52	2.52	2.52	(3.46)	3.46	2.52	(3.46)	3.46	3.46	3.46	3.46	5.12
<b>B</b>	29,5	43	45	46		56	56	58	60	66	66	84	84	55,5x64	84	88	88	88	88	88	126
	1.16	1.69	1.77	1.81		2.20	2.20	2.28	2.36	2.60	2.60	3.30	3.30	2.19x2.52	3.30	3.46	3.46	3.46	3.46	3.46	4.96
<b>C</b>	4	4	4	4		4	4	4	4	4	4	5,5	4	4	5,5	5,5	5,5	5,5	5,5	5,5	7
	.16	.16	.16	.16		.16	.16	.16	.16	.16	.16	.22	.16	.16	.22	.22	.22	.22	.22	.22	.28
<b>D1</b>	3,2	5	5	5		5	5	5	5	5	5	5	(6)	6	5	(6)	6	6	6	6	7
	.13	.20	.20	.20		.20	.20	.20	.20	.20	.20	.20	(.24)	.24	.20	(.24)	.24	.24	.24	.24	.28
<b>D2</b>	8-11	8-19	8-19	8-19		10-22	10-22	10-22	10-22	10-22	10-22	10-22	13-30	10-22	10-22	13-30	13-30	13-30	13-30	13-30	15,5-25
	.31-.43	.31-.75	.31-.75	.31-.75		.39-.87	.39-.87	.39-.87	.39-.87	.39-.87	.39-.87	.39-.87	.51-1.18	.39-.87	.39-.87	.51-1.18	.51-1.18	.51-1.18	.51-1.18	.51-1.18	.61-.98
<b>E</b>	-	36	36	36	(48)	48	48	48	48	48	48	48	(68)	68	48	(68)	68	68	68	68	104
	-	1.42	1.42	1.42	(1.89)	1.89	1.89	1.89	1.89	1.89	1.89	1.89	(2.68)	2.68	1.89	(2.68)	2.68	2.68	2.68	2.68	4.09
<b>M<sup>2</sup></b>	-	4,5	4,5	5,5		5	5,5	7,5	7,5	7,5	7,5	7,5	7,5	7,6	9,4	27,5	27,5	27,5	27,5	27,5	11,9 (32)
	-	.18	.18	.22		.20	.22	.30	.30	.30	.30	.30	.30	.30	.37	1.08	1.08	1.08	1.08	1.08	.47 (1.26)

<sup>2</sup>M, additional length for mounting ER only  
<sup>3</sup>Dimensions in ( ) for ER mounting plate only

<sup>4</sup>Dimensions in ( ) for L800, L1200, L1600

[< back to table of contents >](#)

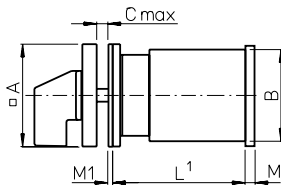

**EF**  
for CA4, CA4-1,  
CAD4-1

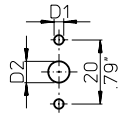

**EF-V**  
for CA4, CA4-1,  
CAD4-1

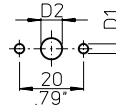

**EF**  
**EF-V**  
**ERF**

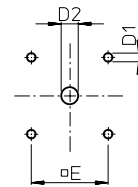

	CA10	CA4	CA11	CA20	CA25 <sup>3</sup>	CA20B	CA10B	CA11B	CA25B	C26	C32	C42 <sup>3</sup>	C43	CA40 <sup>3</sup>	CA50 <sup>3</sup>	CA63 <sup>3</sup>	C125	C200-4	L switches	L switches	
		CAD4-1	CAD12																Size S2	Size S3	
<b>A</b>	30	48	48	48	(64)	64	64	64	64	64	64	64	(88)	88	64	(88)	88	88	88	88	130
	1.18	1.89	1.89	1.89	(2.52)	2.52	2.52	2.52	2.52	2.52	2.52	2.52	(3.46)	3.46	2.52	(3.46)	3.46	3.46	3.46	3.46	5.12
<b>B</b>	29,5	43	45	46		56	56	58	60	66	66	84	84	55,5x64	84	88	88	88	88	88	126
	1.16	1.69	1.77	1.81		2.20	2.20	2.28	2.36	2.60	2.60	3.30	3.30	2.19x2.52	3.30	3.46	3.46	3.46	3.46	3.46	4.96
<b>C</b>	4	4	4	4		4	4	4	4	4	4	5,5	4	4	5,5	5,5	5,5	5,5	5,5	5,5	7
	.16	.16	.16	.16		.16	.16	.16	.16	.16	.16	.22	.16	.16	.22	.22	.22	.22	.22	.22	.28
<b>D1</b>	3,2	5	5	5		5	5	5	5	5	5	5	(6)	6	5	(6)	6	6	6	6	7
	.13	.20	.20	.20		.20	.20	.20	.20	.20	.20	.20	(.24)	.24	.20	(.24)	.24	.24	.24	.24	.28
<b>D2</b>	8-11	15-19	15-19	15-19		19-22	19-22	19-22	19-22	19-22	19-22	19-22	26-30	19-22	19-22	26-30	26-30	26-30	26-30	26-30	22-25
	.31-.43	.59-.75	.59-.75	.59-.75		.75-.87	.75-.87	.75-.87	.75-.87	.75-.87	.75-.87	.75-.87	1.02-1.18	.75-.87	.75-.87	1.02-1.18	1.02-1.18	1.02-1.18	1.02-1.18	1.02-1.18	.87-.98
<b>E</b>	-	36	36	36	(48)	48	48	48	48	48	48	48	(68)	68	48	(68)	68	68	68	68	104
	-	1.42	1.42	1.42	(1.89)	1.89	1.89	1.89	1.89	1.89	1.89	1.89	(2.68)	2.68	1.89	(2.68)	2.68	2.68	2.68	2.68	4.09
<b>M<sup>2</sup></b>	-	4,5	4,5	5,5		5	5,5	7,5	7,5	7,5	7,5	7,5	7,5	7,6	9,4	27,5	27,5	27,5	27,5	27,5	11,9 (32)
	-	.18	.18	.22		.20	.22	.30	.30	.30	.30	.30	.30	.30	.37	1.08	1.08	1.08	1.08	1.08	.47 (1.26)
<b>M1</b>	1	-	-	-		-	-	-	-	-	-	-	-	-	-	-	-	-	-	-	-
	.04	-	-	-		-	-	-	-	-	-	-	-	-	-	-	-	-	-	-	-

<sup>2</sup>M, additional length for mounting ERF only  
<sup>3</sup>Dimensions in ( ) for ERF mounting plate only

<sup>4</sup>Dimensions in ( ) for L800, L1200, L1600

<sup>1</sup>see page 56

**Two or Four Hole Panel Mounting**

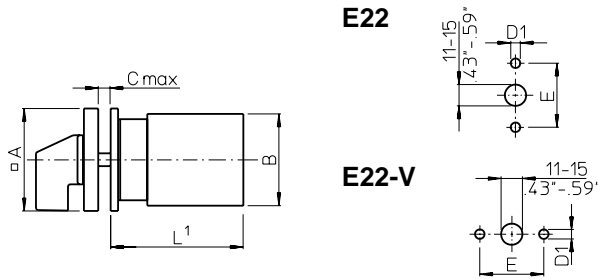

	CA10	CA11	CAD11	CA20	CA25
<b>A</b>	48 1.89	48 1.89		48 1.89	48 1.89
<b>B</b>	43 1.69	45 1.77		46 1.81	46 1.81
<b>C</b>	4 .16	4 .16		4 .16	4 .16
<b>D1</b>	5 .20	5 .20		5 .20	5 .20
<b>E</b>	30 1.17	30 1.17		30 1.17	30 1.17

**EG  
EGF**

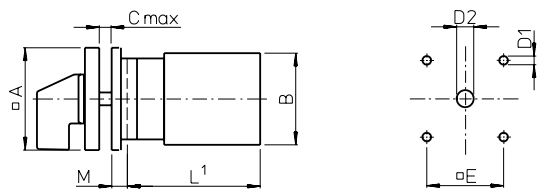

	CA10	CA11	CAD11	CA20	CA25	C26	C32	C42	CA40	CA50	CA63	C80	C125	C200-4
													L switches	Size S2
<b>A</b>	64 2.52	64 2.52		64 2.52	64 2.52	88 3.46	88 3.46	88 3.46	88 3.46	88 3.46	88 3.46	130 5.12	130 5.12	
<b>B</b>	43 1.69	45 1.77		46 1.81	46 1.81	58 2.28	60 2.36	66 2.60	55,5x64 2.19x2.52	84 3.30	84 3.30	88 3.46	88 3.46	
<b>C</b>	4 .16	4 .16		4 .16	4 .16	5.5 .22	5.5 .22	5.5 .22	5.5 .22	5.5 .22	5.5 .22	7 .28	7 .28	
<b>D1</b>	5 .20	5 .20		5 .20	5 .20	6 .24	6 .24	6 .24	6 .24	6 .24	6 .24	7 .28	7 .28	
<b>EG</b>														
<b>D2</b>	10-22 .39-.87	10-22 .39-.87		10-22 .39-.87	10-22 .39-.87	13-30 .51-1.18	13-30 .51-1.18	13-30 .51-1.18	13-30 .51-1.18	13-30 .51-1.18	13-30 .51-1.18	15,5-25 .61-.98	15,5-25 .61-.98	
<b>EGF</b>														
<b>D2</b>	19-22 .75-.87	19-22 .75-.87		19-22 .75-.87	19-22 .75-.87	26-30 1.02-1.18	26-30 1.02-1.18	26-30 1.02-1.18	26-30 1.02-1.18	26-30 1.02-1.18	26-30 1.02-1.18	22-25 .87-.98	22-25 .87-.98	
<b>E</b>	48 1.89	48 1.89		48 1.89	48 1.89	68 2.68	68 2.68	68 2.68	68 2.68	68 2.68	68 2.68	104 4.09	104 4.09	
<b>M</b>	6,7 .26	6,7 .26		6,7 .26	6,7 .26	0,5 .02	0,5 .02	0,5 .02	0,5 .02	0,5 .02	0,5 .02	2 .08	2 .08	

<sup>1</sup>see page 56

**Four Hole Panel Mounting or Mosaic Mounting**

< back to table of contents >

**E9  
E91**

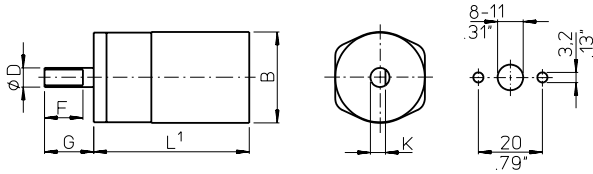

**E92**

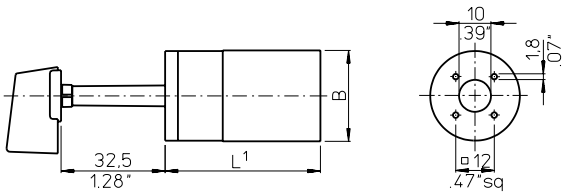

CA4  
CA4  
CAD4-1  
29,5  
1.16

**B**

**E93  
E94**

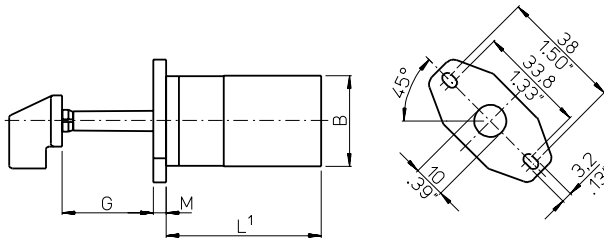

CA4  
CA4-1  
CAD4-1

	<b>E9</b>	<b>E91</b>	<b>E92</b>	<b>E93</b>	<b>E94</b>
<b>D</b>	6 .24	6,35 .25	-	-	-
<b>F</b>	12 .47	12,8 .50	-	-	-
<b>G</b>	15,4 .61	17,4 .69	32,5 1.28	28,5 1.12	32,5 1.28
<b>K</b>	4,7 .19	5,5 .22	-	-	-
<b>M</b>	-	-	-	4 .16	-

**KN1  
KD1  
KN2**

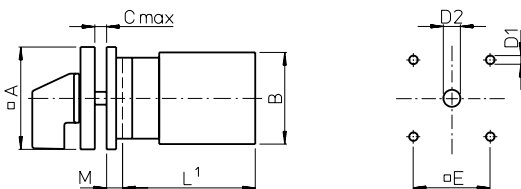

<b>KN2</b>	CA10 CA11 CAD11 CAD12	CA20	CA25
<b>A</b>	48 1.89	48 1.89	48 1.89
<b>B</b>	43 1.69	45 1.77	46 1.81
<b>C</b>	4 .16	4 .16	4 .16
<b>D1</b>	5 .20	5 .20	5 .20
<b>D2</b>	8-19 .31-.75	8-19 .31-.75	8-19 .31-.75
<b>E</b>	36 1.42	36 1.42	36 1.42
<b>M</b>	5,2 .20	5,2 .20	5,2 .20

<b>KN1 KD1</b>	CA10 CA11 CAD11 CAD12	CA20	CA25	CA10B CA11B CA20B	CA25B	C26	C32	C42	CA40 CA50 CA63
<b>A</b>	64 2.52	64 2.52	64 2.52	64 2.52	64 2.52	64 2.52	64 2.52	64 2.52	64 2.52
<b>B</b>	43 1.69	45 1.77	46 1.81	56 2.20	56 2.20	58 2.28	60 2.36	66 2.60	55,5x64 2.19x2.52
<b>C</b>	4 .16	4 .16	4 .16	4 .16	4 .16	4 .16	4 .16	4 .16	4 .16
<b>D1</b>	5 .20	5 .20	5 .20	5 .20	5 .20	5 .20	5 .20	5 .20	5 .20
<b>D2</b>	10-22 .39-.87	10-22 .39-.87	10-22 .39-.87	10-22 .39-.87	10-22 .39-.87	10-22 .39-.87	10-22 .39-.87	10-22 .39-.87	10-22 .39-.87
<b>E</b>	48 1.89	48 1.89	48 1.89	48 1.89	48 1.89	48 1.89	48 1.89	48 1.89	48 1.89
<b>M</b>	4,7 .19	4,7 .19	4,7 .19	7 .28	7 .28	7 .28	7 .28	7 .28	7 .28

<sup>1</sup>see page 56

**Two or Four Hole Panel Mounting**

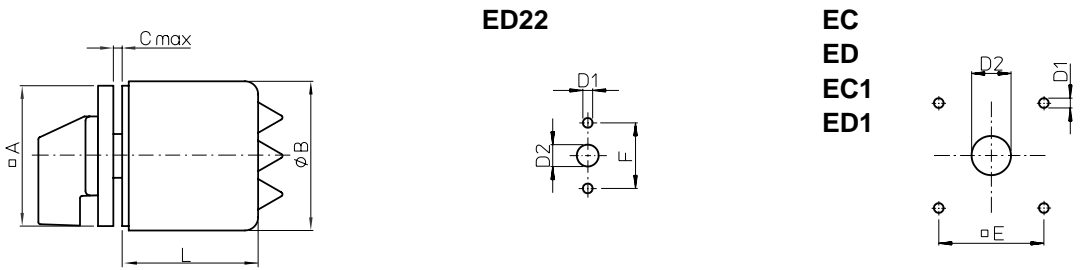

	CA10		CAD11		CAD12		CA11		CA20		CA25		CA10B		CA20B		CA11B		CA25B		C26		
	EC	ED	ED22	ED	ED22	ED	ED22	ED	ED22	ED	ED22	ED	ED22	ED	ED1	ED	ED1	ED	ED1	ED	ED1	ED	ED1
A	48	1.89	48	1.89	48	1.89	48	1.89	64	2.52	64	1.89	2.52	64	2.52	64	2.52	64	2.52	64	2.52	64	2.52
B	50	1.97	74	2.91	50	1.97	74	2.91	68	2.68	74	2.91	2.68	88	3.46	74	2.91	3.46	88	3.46	74	2.91	3.46
C	4	.16	-	-	4	.16	-	-	4	.16	-	-	.16	4	.16	4	.16	.16	.16	.16	.16	.16	.16
D	4	.16	4	.16	4	.16	4	.16	4	.16	4	.16	4	.16	4	.16	4	.16	.16	.16	4	.16	4
D1	5	.20	5	.20	5	.20	5	.20	5	.20	5	.20	5	.20	5	.20	5	.20	.20	.20	5	.20	5
D2	8-19	.31-.75	-	-	8-19	.31-.75	-	-	10-22	.39-.87	-	-	.39-.87	10-22	.39-.87	10-22	.39-.87	.39-.87	.39-.87	.39-.87	.39-.87	10-22	.39-.87
E	15-19	.43-.75	11-15	.43-.59	15-19	.43-.75	11-15	.43-.59	19-22	.75-.87	11-15	.43-.59	.75-.87	19-22	.75-.87	19-22	.75-.87	.75-.87	.75-.87	.75-.87	.75-.87	19-22	.75-.87
F	36	1.42	-	-	36	1.42	-	-	48	1.89	-	-	1.89	48	1.89	48	1.89	48	1.89	48	1.89	48	1.89
M	-	-	30	1.17	-	-	30	1.17	-	-	30	1.17	-	30	1.17	-	-	-	-	-	-	-	-
Stages L	1	53,5	74,3	2,10	53,5	74,3	2,10	2,93	-	74,3	2,93	-	2,93	73,7	2,90	-	2,90	-	73,7	2,90	-	73,7	2,90
2	53,5	74,3	53,5	74,3	53,5	74,3	2,93	-	74,3	2,93	-	2,93	73,7	2,90	-	73,7	2,90	-	73,7	2,90	-	73,7	2,90
3	67,5	74,3	67,5	94,3	67,5	94,3	3,71	-	74,3	2,93	-	3,71	93,7	3,69	-	93,7	3,69	-	93,7	3,69	-	93,7	3,69
4	67,5	74,3	81,5	94,3	67,5	94,3	3,71	-	94,3	3,71	-	3,71	93,7	3,69	-	93,7	3,69	-	93,7	3,69	-	93,7	3,69
5	81,5	94,3	-	-	104	4,10	-	-	104	4,10	-	-	93,7	3,69	104	4,10	-	5	127	5	-	114,5	-
6	81,5	94,3	-	-	-	-	-	-	-	-	-	-	104	4,10	-	127	5	-	139,5	5,47	-	127	-
7	-	-	-	-	-	-	-	-	-	-	-	-	127	5	-	139,5	5,47	-	139,5	5,98	-	139,5	5,47
8	-	-	-	-	-	-	-	-	-	-	-	-	127	5	-	152	5,98	-	164,5	6,48	-	152	5,98
9	-	-	-	-	-	-	-	-	-	-	-	-	139,5	5,47	-	164,5	6,48	-	177	6,97	-	164,5	6,48
10	-	-	-	-	-	-	-	-	-	-	-	-	152	5,98	-	177	6,97	-	-	-	-	177	6,97
11	-	-	-	-	-	-	-	-	-	-	-	-	152	5,98	-	-	-	-	-	-	-	-	-
12	-	-	-	-	-	-	-	-	-	-	-	-	164,5	6,48	-	-	-	-	-	-	-	-	-

< back to table of contents >

Single Hole Mounting or Base Mounting

FS1...  
FT1...  
FT3...

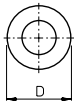

FS1...  
FS2...  
FS4...

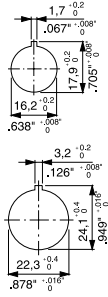

FH3...  
FS2...  
FT2...  
FT4...

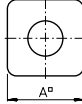

FH3...  
FH4...  
FT1...  
FT2...  
FT6...

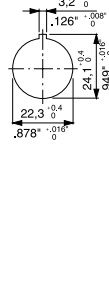

FH4...  
FS4...  
FT6...

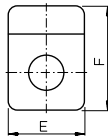

FT3...  
FT4...

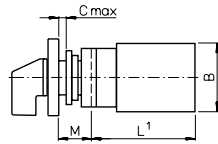
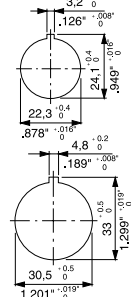

	CA4	CA10	CA11	CAD11	CA20	CA25
A/E	30	48	48	48	48	48
FH3...	1.18	1.89	1.89	1.89	1.89	1.89
FH4...	-	64	64	64	64	64
	-	2.52	2.52	2.52	2.52	2.52
B	28	43	45	46	46	46
	1.10	1.69	1.77	1.81	1.81	1.81
C	5	6	6	6	6	6
	.20	.24	.24	.24	.24	.24
D	29.5	39.4	39.4	39.4	39.4	39.4
	1.16	1.55	1.55	1.55	1.55	1.55
F	39	59	59	59	59	59
	1.54	2.32	2.32	2.32	2.32	2.32
FH4...	-	78.5	78.5	78.5	78.5	78.5
	-	3.09	3.09	3.09	3.09	3.09
M	12.5	18.2	18.2	18.2	18.2	18.2
	.49	.72	.72	.72	.72	.72
FH3...	-	25.2	25.2	25.2	25.2	25.2
	-	.99	.99	.99	.99	.99
FH4...	-	25.2	25.2	25.2	25.2	25.2
	-	.99	.99	.99	.99	.99

< back to table of contents >

VE

VE-V

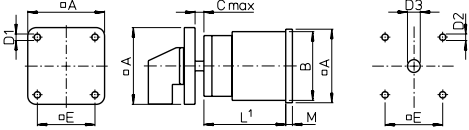

VE22

VE22V

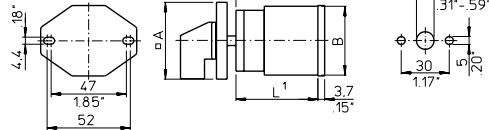

VF

VF-V

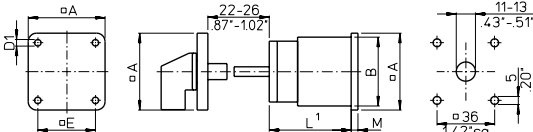

VF22

VF22V

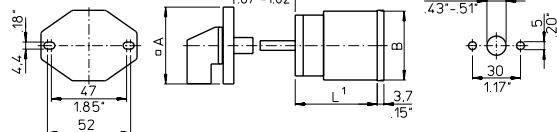

	CA10	CA11	CAD11	CA20	CA25 <sup>2</sup>	CA10B	CA11B	CA20B	CA25B	C26	C32	C42 <sup>2</sup>	C43	CA40 <sup>2</sup>	CA50 <sup>2</sup>	CA63 <sup>2</sup>	C80	C125	C200-4	L switches	L switches
																				Size S2	Size S3
A	48	48	48	48 (64)	48 (64)	64	64	64	64	64	64	64 (88)	88	64 (88)	88	88	88	88	88	88	128
	1.89	1.89	1.89	1.89 (2.52)	1.89 (2.52)	2.52	2.52	2.52	2.52	2.52	2.52	2.52 (3.46)	3.46	2.52 (3.46)	3.46	3.46	3.46	3.46	3.46	3.46	5.04
B	43	45	46	46	46	56	56	56	56	58	60	66	84	55,5x64	84	88	88	88	88	88	126
	1.69	1.77	1.81	1.81	1.81	2.20	2.20	2.20	2.20	2.28	2.36	2.60	3.30	2.19x2.52	3.30	3.46	3.46	3.46	3.46	3.46	4.96
C	10.5	10.5	10.5	10.5	10.5	13.5	13.5	13.5	13.5	13.5	13.5	16	16	13.5	16	16	16	16	16	16	19.3
	.41	.41	.41	.41	.41	.53	.53	.53	.53	.53	.53	.53	.63	.53	.63	.63	.63	.63	.63	.63	.76
D1	4.1	4.1	4.1	4.1	4.1	4.1	4.1	4.1	4.1	4.1	4.1	5.4	5.4	5.4	5.4	5.4	5.4	5.4	5.4	5.4	7
	.16	.16	.16	.16	.16	.16	.16	.16	.16	.16	.16	.21	.21	.21	.21	.21	.21	.21	.21	.21	.28
D2	5	5	5	5	5	5	5	5	5	5	5	5	6	5 (6)	6	6	6	6	6	6	7
	.20	.20	.20	.20	.20	.20	.20	.20	.20	.20	.20	.20	.24	.20 (.24)	.24	.24	.24	.24	.24	.24	.28
D3	8-19	8-19	8-19	8-19	8-19	10-22	10-22	10-22	10-22	10-22	10-22	10-22	13-30	10-22	13-30	13-30	13-30	13-30	13-30	13-30	15.5-25
	.31-.75	.31-.75	.31-.75	.31-.75	.31-.75	.39-.87	.39-.87	.39-.87	.39-.87	.39-.87	.39-.87	.39-.87	.51-1.18	.39-.87	.51-1.18	.51-1.18	.51-1.18	.51-1.18	.51-1.18	.51-1.18	.61-.98
E	36	36	36 (48)	36 (48)	36 (48)	48	48	48	48	48	48	48 (68)	68	48 (68)	68	68	68	68	68	68	104
	1.42	1.42	1.42 (1.89)	1.42 (1.89)	1.42 (1.89)	1.89	1.89	1.89	1.89	1.89	1.89	1.89 (2.68)	2.68	1.89 (2.68)	2.68	2.68	2.68	2.68	2.68	2.68	4.09
M	2.2	2.2	3.2	2.5	2.5	5	5	5	5	5	5	7	7	5.1	8.9	8.9	8.9	8.9	8.9	27	11.4 (31.9)
	.09	.09	.13	.10	.10	.20	.20	.20	.20	.20	.20	.28	.28	.21	.35	.35	.35	.35	.35	1.06	.45 (1.25)

<sup>2</sup>Dimensions in ( ) for revertive mounting plate

<sup>3</sup>Dimensions in ( ) for L800, L1200, L1600

<sup>1</sup>see page 56

**Base Mounting**

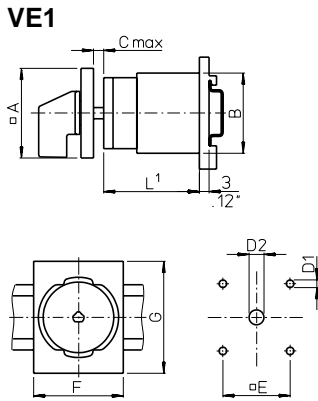

	CA10	CA11	CAD11	CA20	CA25	CA10B	CA11B	CA20B	CA25B	C26	C32	C42	CA40	CA50	CA63
<b>A</b>	48	48	48	48	48	64	64	64	64	64	64	64	64	64	64
	1.89	1.89	1.89	1.89	1.89	2.52	2.52	2.52	2.52	2.52	2.52	2.52	2.52	2.52	2.52
<b>B</b>	43	45	46	46	46	56	56	56	58	60	66	66	55,5x64	55,5x64	55,5x64
	1.69	1.77	1.81	1.81	1.81	2.20	2.20	2.20	2.28	2.36	2.60	2.60	2.19x2.52	2.19x2.52	2.19x2.52
<b>C</b>	10,5	10,5	10,5	10,5	10,5	13,5	13,5	13,5	13,5	13,5	13,5	13,5	13,5	13,5	13,5
	.41	.41	.41	.41	.41	.53	.53	.53	.53	.53	.53	.53	.53	.53	.53
<b>D1</b>	5	5	5	5	5	5	5	5	5	5	5	5	5	5	5
	.20	.20	.20	.20	.20	.20	.20	.20	.20	.20	.20	.20	.20	.20	.20
<b>D2</b>	8-15	8-15	8-15	8-15	8-15	10-15	10-15	10-15	10-15	10-15	10-15	10-15	10-15	10-15	10-15
	.31-.59	.31-.59	.31-.59	.31-.59	.31-.59	.39-.59	.39-.59	.39-.59	.39-.59	.39-.59	.39-.59	.39-.59	.39-.59	.39-.59	.39-.59
<b>E</b>	36	36	36	36	36	48	48	48	48	48	48	48	48	48	48
	1.42	1.42	1.42	1.42	1.42	1.89	1.89	1.89	1.89	1.89	1.89	1.89	1.89	1.89	1.89
<b>F</b>	48	48	48	48	48	70	70	70	70	70	70	70	70	70	70
	1.89	1.89	1.89	1.89	1.89	2.76	2.76	2.76	2.76	2.76	2.76	2.76	2.76	2.76	2.76
<b>G</b>	60	60	60	60	60	60	60	60	60	60	60	60	60	60	60
	2.36	2.36	2.36	2.36	2.36	2.36	2.36	2.36	2.36	2.36	2.36	2.36	2.36	2.36	2.36

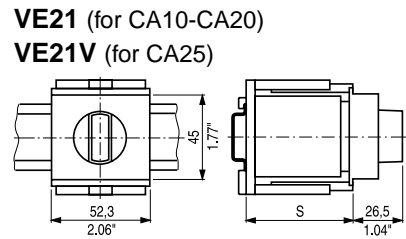
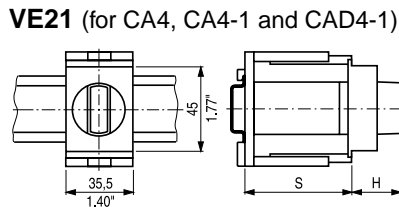
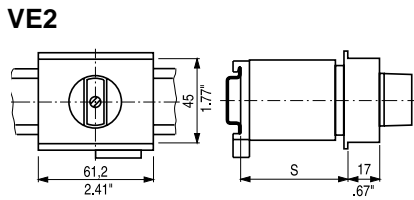

	<b>VE2</b>				<b>S<sub>min.</sub></b>	<b>H</b>	<b>VE21, VE21V</b>				
	CA10	CA11	CA20	CA25			CA4	CA10	CA11	CA20	CA25
	Max. no. of stages						No. of stages				
<b>S</b> = 46 1.81	3	1	-	-	44 1.73	21 .83	1/2	1/2	1/2	1/2	1
<b>S</b> = 50 1.97	-	-	1	-	46 1.81	26,5 1.04	3	3	-	-	2
<b>S</b> = 61 2.40	4	2	2	-	54 2.13	26,5 1.04	4	-	-	-	-
<b>S</b> = 67 2.64	5	-	-	-	56 2.20	-	-	-	3	3	-
<b>S</b> = 69 2.70	-	3 <sup>2</sup>	3	-	60 2.36	-	-	-	-	-	3
					62 2.44	26,5 1.04	5	-	-	-	-
					66 2.60	-	-	4/5	-	-	-
					68 2.68	-	-	-	4	-	-
					70 2.76	26,5 1.04	6	-	-	4	-
					74 2.91	-	-	6	-	-	4

<sup>1</sup>see page 56    <sup>2</sup>not available for switch type CA20

**Dimensions**      mm  
inch

**Wall Mounting, Face plates and Additional Length**

**UE1  
UE2  
UE3**

**Lamp**

	CA10	CA11	CAD11	CA20	CA25
<b>B</b>	43	45	46	46	46
	1.69	1.77	1.81	1.81	1.81

**Face plates for mounting E, EF, ER, ERF, EG, EGF, KN1, KD1, KN2, EC, EC1, ED, ED1, VE, VE1, VF**

Size	A	C
<b>S00</b>	30	5,5
	1.18	.22
<b>S0</b>	48	6,7
	1.89	.26
<b>S1</b>	64	7,4
	2.52	.29
<b>S2</b>	88	8,5
	3.46	.33
<b>S3</b>	130	11,5
	5.12	.45

Size	A	B	C
<b>S00</b>	30	39	5,5
	1.18	1.54	.22
<b>S0</b>	48	59	6,7
	1.89	2.32	.26
<b>S1</b>	64	78	7,4
	2.52	3.07	.29

< back to table of contents >

**Additional length for amendment (page 6)**

Amendment	CAD11	CAD12	CA10 CA11 CA20 CA25	C26	C32	C42	CA40 CA50 CA63
<b>B</b> S0 switches with latching mechanism size S1	5,4 .21	-	-	-	-	-	-
<b>C</b> S1 switches with latching mechanism size S2	-	-	9,2 .36	9,2 .36	-	-	8,2 .32
<b>S</b> with snap action	-	17,3 .68	12,2 .48	12,2 .48	12,2 .48	12,2 .48	12,2 .48

**Quick connects for switches CA4-4**

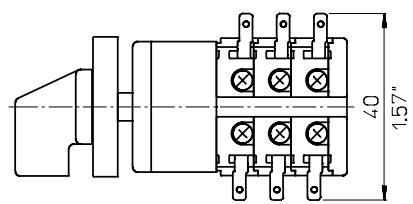

<sup>1</sup>see page 56

**Additional Length**

**Terminal lugs for switches C200-4-, C315, C316 and L switches**

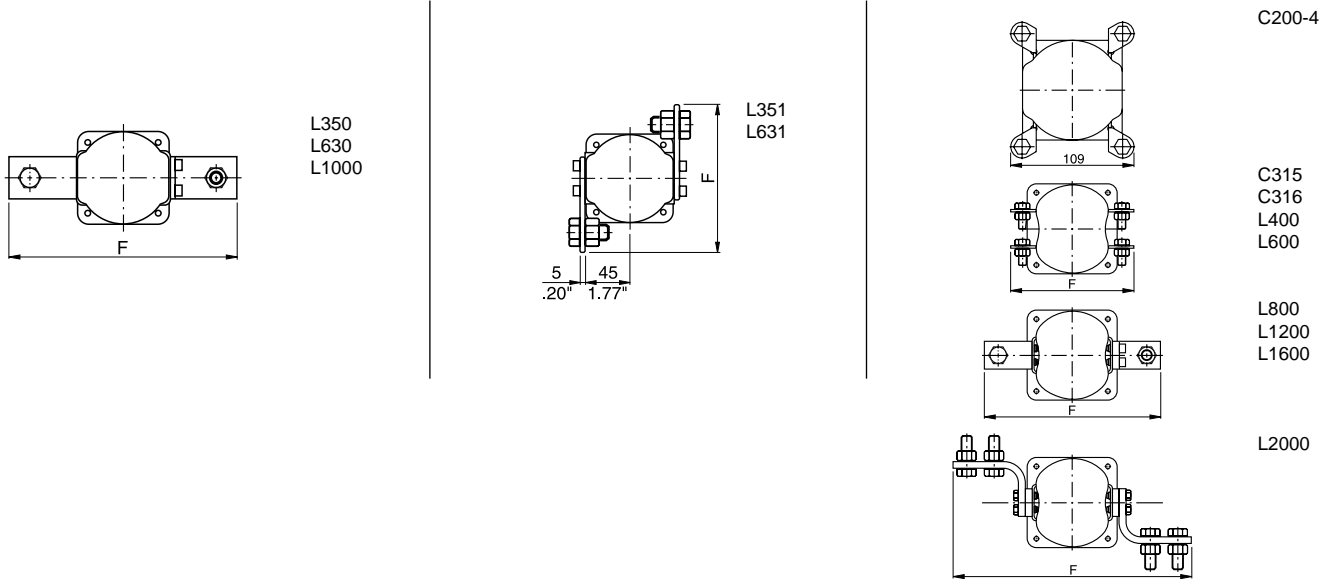

F	L350	L630	L1000	L351	L631	C315			L800	L1600
						C316	L400	L600	L1200	L2000
	190	220	230	138	148	150	180	208	256	326
	7.48	8.66	9.06	5.43	5.83	5.91	7.09	8.19	10.08	12.83

**Length L**

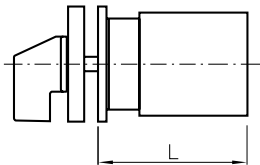

Stages	CA4	CA10											CA40	C125	C315		
	CA4-1	CAD11	CA11	CA20	CA25	CA10B	CA11B	CA20B	CA25B	C26	C32	C42	C43	CA50	C80	L switches	L switches
	CAD4-1	CAD12	CA11	CA20	CA25	CA10B	CA11B	CA20B	CA25B	C26	C32	C42	C43	CA63	C80	Size S2	Size S3
<b>1</b>	30	33,5	36,7	37,7	39	38,9	42,1	43,1	44,4	42	46,8	50,8	59	42,5	61,5	67,5	78,6
	1.18	1.32	1.44	1.48	1.51	1.53	1.66	1.70	1.75	1.65	1.84	2.00	2.32	1.67	2.42	2.66	3.09
<b>2</b>	38	43	49,4	50,4	53	48,4	54,8	55,8	58,4	54,7	64,3	72,3	80,5	55,2	88,0	100	117,2
	1.50	1.69	1.94	1.98	2.09	1.91	2.16	2.20	2.30	2.15	2.51	2.85	3.17	2.17	3.46	3.94	4.61
<b>3</b>	46	52,5	62,1	63,1	67	57,9	67,5	68,5	72,4	67,4	81,8	93,8	102	67,9	114,5	132,5	155,8
	1.81	2.07	2.44	2.48	2.64	2.28	2.66	2.70	2.85	2.65	3.22	3.69	4.02	2.67	4.51	5.22	6.13
<b>4</b>	54	62	74,8	75,8	81	67,4	80,2	81,2	86,4	80,1	99,3	115,3	123,5	80,6	141	165	194,4
	2.13	2.44	2.94	2.98	3.19	2.65	3.16	3.20	3.40	3.15	3.91	4.54	4.86	3.17	5.55	6.50	7.65
<b>5</b>	62	71,5	87,5	88,5	95	76,9	92,9	93,9	100,4	92,8	116,8	136,8	145	93,3	167,5	197,5	233
	2.44	2.81	3.44	3.48	3.74	3.03	3.66	3.70	3.95	3.65	4.60	5.39	5.71	3.67	6.59	7.78	9.17
<b>6</b>	70	81	100,2	101,2	109	86,4	105,6	106,6	114,4	105,5	134,3	158,3	166,5	106	194	230	271,6
	2.76	3.19	3.94	3.98	4.29	3.40	4.16	4.20	4.50	4.15	5.29	6.23	6.56	4.17	7.64	9.06	10.69
<b>7</b>	78	90,5	112,9	113,9	123	95,9	118,3	119,3	128,4	118,2	151,8	179,8	188	118,7	220,5	262,5	310,2
	3.07	3.56	4.44	4.48	4.84	3.78	4.66	4.70	5.05	4.65	5.98	7.08	7.40	4.67	8.68	10.33	12.21
<b>8</b>	86	100	125,6	126,6	137	105,4	131	132	142,4	130,9	169,3	201,3	209,5	131,4	247	295	348,8
	3.39	3.94	4.94	4.98	5.39	4.15	5.16	5.20	5.60	5.15	6.67	7.93	8.25	5.17	9.72	11.61	13.73
<b>9</b>	94	109,5	138,3	139,3	151	114,9	143,7	144,7	156,4	143,6	186,8	222,8	231	144,1	273,5	327,5	387,4
	3.70	4.31	5.44	5.48	5.94	4.52	5.66	5.70	6.15	5.65	7.36	8.77	9.09	5.67	10.77	12.89	15.25
<b>10</b>	-	119	151	152	165	124,4	156,4	157,4	170,4	156,3	204,3	244,3	252,2	156,8	300	360	426
	-	4.68	5.94	5.98	6.50	4.90	6.16	6.20	6.70	6.15	8.04	9.62	9.54	6.17	11.81	14.17	16.77
<b>11</b>	-	128,5	163,7	164,7	179	133,9	169,1	170,1	184,4	169	221,8	265,8	274	169,5	326,5	392,5	464,6
	-	5.06	6.44	6.48	7.05	5.27	6.66	6.70	7.25	6.65	8.73	10.46	10.79	6.67	12.85	15.45	18.29
<b>12</b>	-	138	176,4	177,4	193	143,4	181,8	182,8	198,4	181,7	239,3	287,3	295,5	182,2	353	425	503,2
	-	5.43	6.94	6.98	7.60	5.65	7.16	7.20	7.80	7.15	9.42	11.31	11.63	7.17	13.90	16.73	19.81

< back to table of contents >



**Notes:**

[< back to table of contents >](#)

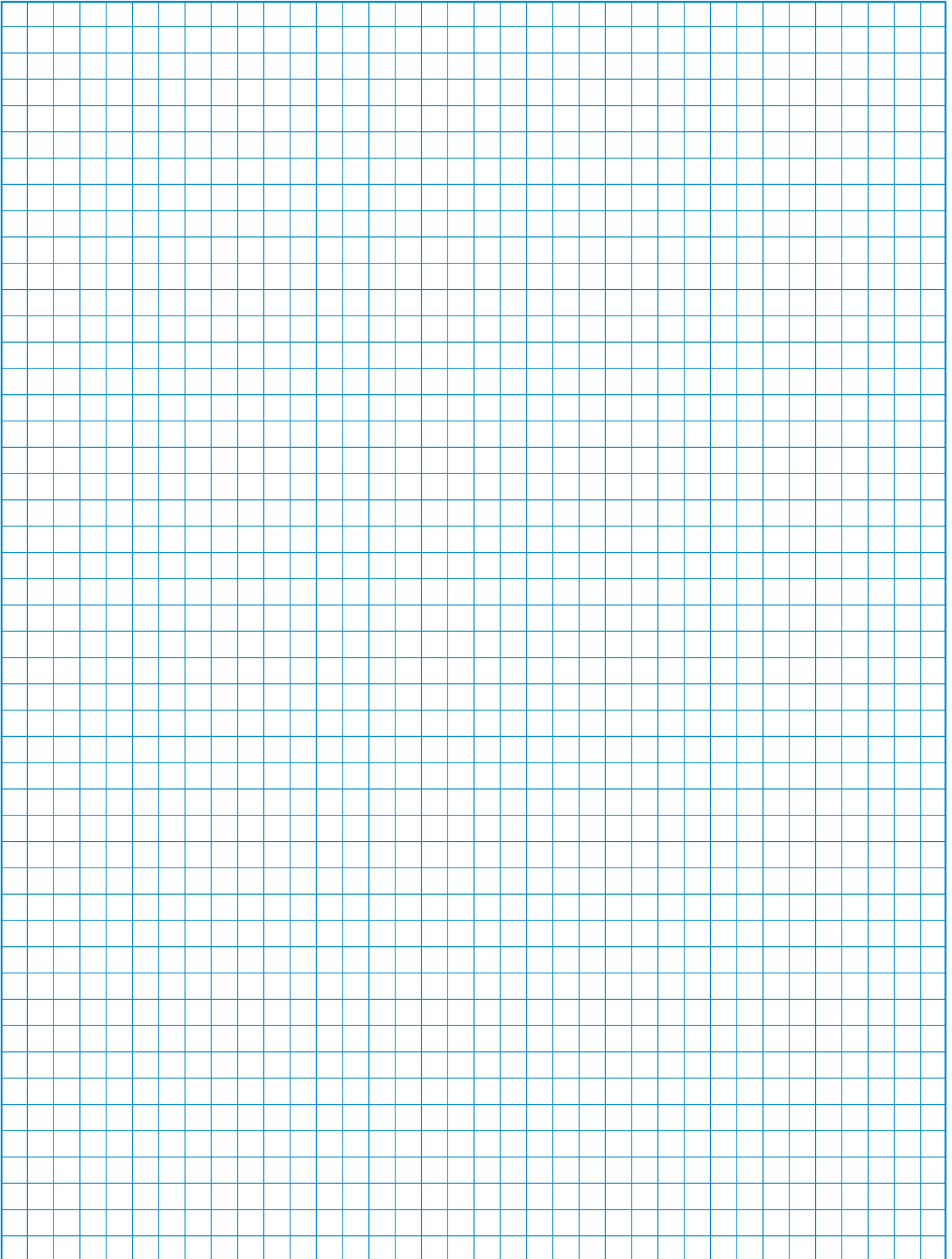

---

# The Range of “Blue Line” Switchgear

Technical literature covering the following products is available on request.

	Catalog Number
<b>Main Switches and Main Switches with Emergency Function 16 A-315 A Maintenance Switches 20 A-315 A Switch Disconnectors 20 A-315 A</b> According to IEC 60947-3, EN 60947-3, VDE 0660 part 107, IEC 60204, EN 60204 and VDE 0113	<b>500</b>
<b>C, CA and CAD Switches 10 A-315 A and L Switches 350 A-2400 A</b> C, CA and CAD switches are designed for universal application. They are recommended for instrument, isolator, double-throw and motor control. L switches are designed for load and off-load applications. They are used to switch resistive or low inductive loads.	<b>100</b>
<b>Optional Extras and Enclosures</b> The complete product line, a large number of optional extras is available, including door interlocks, push-pull devices, cylinder and padlock attachments, control and indicator devices, AC motor drives, as well as enclosures, both insulated and metal.	<b>101</b>
<b>A and AD Switches 6 A-25 A</b> A and AD switches have 4 contacts in each switching stage. These switches provide an extensive range of switch functions and require a minimum mounting depth. Up to 24 switching positions are possible, with availability of 48 contacts per 12 stage switch column.	<b>110</b>
<b>CG, CH and CHR Switches 10 A-25 A</b> Ultra compact CG, CH and CHR switches are ideally suited for control and instrumentation applications. Switch terminals are “finger-proof” and conveniently accessible for wiring and are delivered open. All CG4 switches offer specially designed gold plated contacts or H-bridges with “cross-wire” contact systems, which facilitates their use in electronic circuitry and chemically aggressive environments.	<b>120</b>
<b>DH, DHR, DK and DKR Switches 6 A-16 A</b> DH, DHR, DK and DKR switches incorporate unique corrosion resistant contacts that permit operation on system voltage as low as 1 V. They have fully enclosed and protected contacts which can be operated either by rotary and/or lateral handle movement. D switches are used in calibration and semiconductor circuits. They are also used for relay and contactor control.	<b>130</b>
<b>X Switches 200 A-630 A</b> X switches can be applied for load, tap and gang switching duties. They incorporate 6 contacts in each switching stage. Their compact design provides a minimum length dimension for mounting purposes.	<b>140</b>
<b>KG Switches 20 A-315 A and KH and KHR Switches 16 A-80 A</b> KG, KH and KHR switches are excellent circuit interruptors. They have high through fault and fault making capacities and are especially designed for use as isolators and safety switches for machine tools, distribution panels and switchboards. KG ON/OFF switches offer unusually high dimensioned air and creepage distances between terminals which are designed for time saving “straight-line” wiring. ON/OFF switches are available with up to 8 poles and double-throw switches are available with up to 4 poles.	<b>150</b>
<b>Push Buttons and Pilot Lights, 22,5 mm Ø</b> A complete range of state-of-the-art push buttons and pilot lights represent an ideal combination of functional security and economical efficiency in a modular design.	<b>302</b>

**Australia**

Kraus & Naimer Pty. Ltd.  
379 Liverpool Road, ASHFIELD, N.S.W. 2131  
P: 1800 567 948  
E: sales-au@krausnaimer.com

**Austria**

Kraus & Naimer GmbH  
Schumannngasse 39  
1180 WIEN  
P: +43 1 404 06 0  
E: sales-at@krausnaimer.com

**Belgium, Luxembourg**

Kraus & Naimer B.V.  
Ikaros Business Park  
Ikaroslaan 2  
1930 ZAVENTHEM  
P: +32 2 757 0141  
F: +32 2 757 1640  
E: sales-be@krausnaimer.com

**Brazil**

**Central and South America**  
Kraus & Naimer Ind. Com. Ltda.  
Rua Santa Monica, 1061  
Parque Industrial San Jose  
P: +55 11 2198 1288  
F: +55 11 2198 1251  
E: knbrasil@krausnaimer.com.br

**Canada**

Kraus & Naimer Ltd.  
219 Connie Crescent, Unit 13A  
CONCORD, Ontario, L4K 1L4  
P: +1 905 738 1666  
E: sales-ca@krausnaimer.com

**Cyprus**

ELECTROMATIC CONSTRUCTIONS LTD.  
72, Evagoras Pallikarides Str., 2235 LATSIA-Nicosia  
P. O. Box 12630, 2251 LATSIA-Nicosia  
P: +357 2 48 41 41  
F: +357 2 48 57 47  
E: electromatic@cytanet.com.cy

**Czech Republic**

OBZOR, výrobní družstvo Zlín  
Na Slanici 378  
763 02 ZLÍN  
P: +420 577 195 150  
F: +420 577 195 152  
E: odbyt@obzor.cz

**Denmark**

THIIM A/S  
Transformervej 31  
2860 SOEBORG  
P: +45 4485 8000  
F: +45 4485 8005  
E: thiim@thiim.com

**Finland**

Kraus & Naimer Oy  
Kiitoradankuja 8  
01530 VANTAA  
P: +358 9 825 424 0  
E: sales-fi@krausnaimer.com

**France**

Kraus & Naimer s.a.s.  
33, rue Bobillot  
75013 PARIS  
P: +33 1 58 40 80 80  
E: sales-fr@krausnaimer.com

**Germany**

Kraus & Naimer GmbH  
Wikingerstraße 20-28, 76189 KARLSRUHE  
Postfach 10 01 24, 76231 KARLSRUHE  
P: +49 721 59 88 0  
E: sales-de@krausnaimer.com

**Great Britain**

Kraus & Naimer Ltd.  
115 London Road  
NEWBURY/BERKSHIRE RG14 2AH  
P: +44 1635 262626  
F: +44 1635 37807  
E: sales-uk@krausnaimer.com

**Greece**

KALAMARAKIS-SAPOUNAS S. A.  
Ionias & Neromilou Str., P. O. Box 46566  
13671 ACHARNES/ATHENS  
P: +30 2 10 240 6000 6  
F: +30 2 10 240 6007  
E: kalamarakis.sapounas@ksa.gr

**Hungary**

GANZ KK KFT.  
X. Kőbányai út 41/c, Postfach 87  
1475 BUDAPEST  
P: +36 1 261 5479  
E: ganzkk@ganzkk.hu

**Iceland**

JOHAN RÖNNING LTD.  
Klettgarðar 25  
104 REYKJAVIK  
P: +354 5200 800  
E: ronning@ronning.is

**Republic of Ireland**

Kraus & Naimer Ltd.  
4235 Atlantic Avenue  
Westpark Business Campus  
Shannon, Co. Clare  
P: +353 61 704700  
F: +353 61 471084  
E: sales-ie@krausnaimer.com

**Italy**

Kraus & Naimer s.r.l.  
Via Terracini, 9  
24047 TREVIGLIO (BG)  
P: +39 0363 30 11 12  
E: sales-it@krausnaimer.com

**Japan**

Kraus & Naimer Ltd.  
Yoshiwada Building 2F  
1-11-6 Hamamatsucho  
Minato-Ku, TOKYO 105-0013  
P: +81 3 3436 6151  
F: +81 3 3436 6325  
E: sales-jp@krausnaimer.com

**Mexico**

JC INGENIERÍA Y CONTROL, SA DE CV.  
Ángel Gavilño 30.  
C. Satélite, C. Medicos,  
Naucalpan Edo. de Mexico, C.P. 53100  
P: +52 55 55 62 75 77  
F: +52 55 55 62 04 34  
E: ventas@jcingenieriacontrol.com

**Netherlands**

Kraus & Naimer B.V.  
Wegtersweg 38-40, Postbus 199  
7556 BR HENGEL0 (Ov.)  
P: +31 74 291 9441  
F: +31 74 291 98380  
E: sales-nl@krausnaimer.com

**New Zealand**

Kraus & Naimer Ltd.  
42 Miramar Avenue, WELLINGTON 6022  
P. O. Box 15-009, WELLINGTON 6243  
P: + 64 0800 736 522  
E: sales-nz@krausnaimer.com

**Norway**

Kraus & Naimer AB Avd. Norge  
Postboks 27 Vollebekk  
0516 Oslo  
P: +47 22 64 44 20  
E: sales-no@krausnaimer.com

**Poland**

ASTAT LOGISTYKA SP. Z O.O.  
Dąbrowskiego 441  
60451 POZNAŃ  
P: +48 61 849 80 89  
E: k.swiderski@astat.pl

**Portugal**

ELECTRICOL-DAMAS, FERREIRA & DAMASCENO, LDA.  
Apartado 1063, S. Ant. Cavaleiros  
2670 LOURES  
P: +351 21 989 8939  
F: +351 21 988 6464  
E: electrical@electricol.pt

**Singapore, India, Middle East – UAE**

Kraus & Naimer Pte. Ltd.  
115A, Commonwealth Drive  
#03-17/23  
SINGAPORE 149 596  
P: +65 6473 8166  
E: sales-sg@krausnaimer.com

**Slovenia**

SCHRACK TECHNIK D.O.O.  
Pameče 175  
SI-2380 SLOVENJ GRADEC  
P: +386 2 88 392 00  
F: +386 2 88 434 71  
E: d.goljat@schrack.si

**Republic of South Africa**

Kraus & Naimer Pty. Ltd.  
7 Village Crescent, Linbro Village  
Linbro Business Park, SANDTON 2065  
P. O. Box 511, KELVIN 2054  
P: +27 11 608 6060  
E: sales-za@krausnaimer.com

**Spain**

Kraus & Naimer B.V.  
P: +34 662 696 014  
E: sales-es@krausnaimer.com

**Sweden**

Kraus & Naimer AB  
Dr. Widerströms Gata 11, Hågersten  
Box 42097, 126 14 STOCKHOLM  
P: +46 8 97 00 80  
E: sales-se@krausnaimer.com

**Switzerland**

AWAG Elektrotechnik AG  
Sandbühlstraße 2  
CH-8604 VOLKETSCHWIL  
P: +41 44 908 19 19  
E: info@awag.ch

**Turkey**

KARDES ELEKTRİK SANAYİ VE TİCARET A.S.  
Yassıoren Mah. Hıfı Sok. No: 4  
34277 Arnavutköy-Istanbul-Turkey  
P: +90 212 624 92 04 118  
F: +90 212 592 48 10  
E: info@unalkardes.com.tr

**USA**

Kraus & Naimer Inc.  
760 New Brunswick Road  
SOMERSET, NJ 08873  
P: +1 732 560 1240  
E: sales-us@krausnaimer.com

---



Kraus & Naimer

---



---

**Contact us:**

[www.krausnaimer.com](http://www.krausnaimer.com)