

# Solid State Relays 1-Phase with Integrated Heatsink Proportional Switching Controllers Types RGC1P..AA., RGC1P..V..



- 1-pole analog switching AC solid state contactors
- Selectable mode of operation:
  - Phase Angle
  - Full Cycle x1, x4, x16
  - Advanced Full Cycle
  - Soft Starting
- Rated operational voltage: up to 660 VAC
- Rated operational current: up to 63 AAC
- Control inputs: 4-20 mA, 0-5 V, 1-5 V, 0-10 V, external potentiometer
- Integrated varistor protection on output
- Load ON LED indication
- 100kA short circuit current rating according to UL508
- DIN or panel mount



## Product Description

The RGC1P is a series of solid state contactors (with integrated heatsink) that give the possibility to control output power of 1-phase loads with an analog control input. Input types cover a wide range of current and voltage ranges. Local setting by an external potentiometer is possible. Switching modes, selectable through a front knob, allow phase angle control, full cycle control,

advanced full cycle control specific for short wave infrared heaters and soft starting for limiting inrush current of loads having a high temperature coefficient.

The output of the RGC1P is protected against overvoltages by means of an integrated varistor across the output. Two front LEDs indicate the status of the load and control.

Specifications are at a surrounding temperature of 25°C unless otherwise specified.

## Ordering Key

**RGC 1 P 60 V 42 E D**

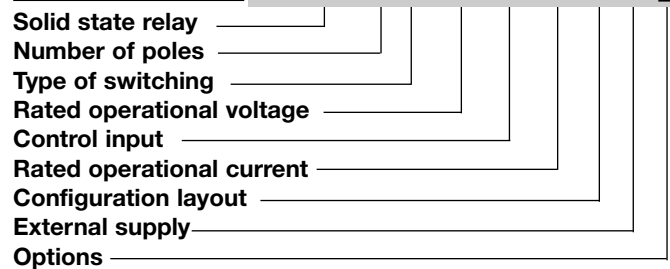

## Type Selection

SSR with heatsink	Type of switching	Rated voltage (Ue), Blocking voltage	Control input <sup>1</sup>	Rated current <sup>2</sup> @40°C, I <sub>2t</sub>	Connection configuration	External supply (Us)	Options
RGC1: 1-pole switching	P: Proportional	23: 85 - 265 VAC, 800 Vp	AA: 4-20 mADC	12: 15 AAC, 1,800 A <sup>2</sup> s 30: 30 AAC, 1,800 A <sup>2</sup> s 42: 43 AAC, 18,000 A <sup>2</sup> s	E: Contactor	D: 24 VDC / AC A: 90 - 250 VAC	T: Tamper proof cover & securness tie included in packaging
		48: 190 - 550 VAC, 1200 Vp	V: 0-5 VDC 1- 5 VDC	50: 50 AAC, 3,200 A <sup>2</sup> s 62: 63 AAC, 18,000 A <sup>2</sup> s			
		60: 410 - 660 VAC, 1200 Vp	0-10 VDC External potentiometer				

1: 'V' control input versions require an external supply Us  
2: Refer to Current Derating

## Selection Guide

Output voltage, U <sub>e</sub>	Control input	External supply, U <sub>s</sub>	Power connection	Rated operational current @ 40°C (I <sub>rt</sub> )					
				15 AAC (1,800 A <sup>2</sup> s) 35 mm	30 AAC (1,800 A <sup>2</sup> s) 35 mm	43 AAC (18,000 A <sup>2</sup> s) 35 mm	50 AAC (3,200 A <sup>2</sup> s) 70 mm	63 AAC (18,000 A <sup>2</sup> s) 70 mm	
85 - 265 VAC	AA: 4-20 mA DC	-	Screw	RGC1P23AA12E	RGC1P23AA30E	-	-	-	
			Box	-	-	RGC1P23AA42E RGC1P23AA42ET	RGC1P23AA50E	RGC1P23AA62E	
	V: 0-10V, 0-5V, 1-5VDC, pot	24 VDC/AC	Screw	RGC1P23V12ED	RGC1P23V30ED	-	-	-	
			Box	-	-	RGC1P23V42ED RGC1P23V42EDT	RGC1P23V50ED	RGC1P23V62ED	
		90-250 VAC	Screw	RGC1P23V12EA	RGC1P23V30EA	-	-	-	
			Box	-	-	RGC1P23V42EA	-	RGC1P23V62EA	
	190 - 550 VAC	AA: 4-20 mA DC	-	Screw	RGC1P48AA12E	RGC1P48AA30E	-	-	-
				Box	-	-	RGC1P48AA42E RGC1P48AA42ET	RGC1P48AA50E	RGC1P48AA62E
V: 0-10V, 0-5V, 1-5VDC, pot		24 VDC/AC	Screw	RGC1P48V12ED	RGC1P48V30ED	-	-	-	
			Box	-	-	RGC1P48V42ED	RGC1P48V50ED	RGC1P48V62ED	
		90-250 VAC	Screw	RGC1P48V12EA	RGC1P48V30EA	-	-	-	
			Box	-	-	RGC1P48V42EA	-	RGC1P48V62EA	
410 - 660 VAC		AA: 4-20 mA DC	-	Screw	-	RGC1P60AA30E	-	-	-
				Box	-	-	RGC1P60AA42E	-	RGC1P60AA62E
	V: 0-10V, 0-5V, 1-5VDC, pot	24 VDC/AC	Screw	-	RGC1P60V30ED	-	-	-	
			Box	-	-	RGC1P60V42ED	-	RGC1P60V62ED	
		90-250 VAC	Screw	-	RGC1P60V30EA	-	-	-	
			Box	-	-	RGC1P60V42EA	-	RGC1P60V62EA	

## General Specifications

	RGC1P..AA	RGC1P..V
Operational frequency range	45 to 65 Hz	45 to 65 Hz
Power factor	> 0.7 @ rated voltage	> 0.7 @ rated voltage
Touch Protection	IP20	IP20
LED status indication <sup>3</sup>		
	Green	Control input <4 mA, flashing 0.5s ON, 0.5s OFF >4 mA, fully on, intensity varies with input
		Supply ON (Us) n/a
	Yellow	Load ON
Pollution degree	2 (non-conductive pollution with possibilities of condensation)	2 (non-conductive pollution with possibilities of condensation)
Over-voltage category	III (fixed installations)	III (fixed installations)
Isolation		
L1, T1, A1, A2, A3, POT, GND, Us to case	4000 Vrms	4000 Vrms
L1, T1 to A1, A2, A3, Pot, GND, Us	2500 Vrms	2500 Vrms
Us to A1, A2, A3, POT, GND	n/a	n/a (..V..ED) 1500 Vrms (..V..EA)

3: Refer to LED Indications section

## Output Voltage Specifications

	RGC1P23..	RGC1P48..	RGC1P60..
Operational voltage range (Ue)	85-265 VAC	190-550 VAC	410-660 VAC
Blocking voltage	800 Vp	1200 Vp	1200 Vp
Leakage current @ rated voltage	≤ 5 mAAC	≤ 5 mAAC	≤ 5 mAAC
Internal Varistor across output	Yes	Yes	Yes

## Output Specifications

	RGC1P..12	RGC1P..30	RGC1P..42	RGC1P..50	RGC1P..62
Rated operational current per pole <sup>4</sup>					
AC-51 @ Ta=25 °C	18 AAC	30 AAC	50 AAC	58 AAC	73 AAC
AC-51 @ Ta=40 °C	15 AAC	30 AAC	43 AAC	50 AAC	63 AAC
AC-55b @ Ta=40 °C <sup>5</sup>	15 AAC	30 AAC	43 AAC	50 AAC	63 AAC
Minimum operational current	250 mAAC	250 mAAC	500 mAAC	500 mAAC	500 mAAC
No. of starts <sup>5</sup>	500	15	200	6	350
Rep. Overload Current PF = 0.7 UL508: T=40°C, tON=1s, tOFF=9s, 50cycles	51 AAC	84 AAC	126 AAC	126 AAC	168 AAC
Maximum transient surge current (I <sub>tsm</sub> ), t=10ms	600 Ap	600 Ap	1900 Ap	800 Ap	1900 Ap
I <sup>2</sup> t for fusing (t=10ms), minimum	1800 A <sup>2</sup> s	1800 A <sup>2</sup> s	18000 A <sup>2</sup> s	3200 A <sup>2</sup> s	18000 A <sup>2</sup> s
Critical dv/dt (@ T <sub>j</sub> init = 40°C)	1000 V/us	1000 V/us	1000 V/us	1000 V/us	1000 V/us

4: refer to Current Derating

5: Overload profile for AC-55b, I<sub>e</sub>: AC-55b: 6x I<sub>e</sub> - 0.2: 50 - x; where I<sub>e</sub> = nominal current (AAC), 0.2 is the duration of the overload (6xI<sub>e</sub>) in seconds, 50 is the duty cycle in %, and x = no. of starts. The overload profile for RGC1P..62 is AC-55b:4.7xI<sub>e</sub> - 0.2 : 50-x

## Supply Specifications

	RGC1P..V..D	RGC1P..V..A
Supply voltage range (U <sub>s</sub> ) <sup>6</sup>	24 VDC, -15% / +20% 24 VAC, -15% / +15%	90-250 VAC -
Overvoltage protection	up to 32 VDC/AC for 30 sec.	n/a
Reverse Protection	Yes	n/a
Surge Protection <sup>7</sup>	Yes, integrated	Yes, integrated
Max. supply current	30 mA	14 mA

6. 24 VAC/DC to be supplied from a Class 2 power source

7. Refer to Electromagnetic Compatibility section

## Input Specifications

	RGC1P..AA	RGC1P..V
Control input	4-20 mADC (A1-A2)	0-10 VDC (A1-GND) 0-5 VDC (A2-GND) 1-5 VDC (A3-GND)
Pickup current, minimum	4.3 mADC	-
Drop out current	3.9 mADC	-
Pick up voltage		
0-5 VDC, 0-10 VDC range	-	0.5 VDC
1-5 VDC range	-	1.5 VDC
Drop out voltage		
0-5 VDC, 0-10 VDC range	-	0.05 VDC
1-5 VDC range	-	1.02 VDC
Potentiometer input	-	10k ohms (GND - A2 - POT)
Maximum initialisation time	280 ms	250 ms
Response time (Input to Output)		
Modes 1, 5, 7	2 half cycles	2 half cycles
Modes 2, 3, 4, 6	3 half cycles	3 half cycles
Voltage drop	<10 VDC @ 20 mA	n/a
Input impedance	n/a	100k ohms
Linearity (Output resolution)	Refer to Transfer Characteristics section, note 9	
Reverse protection	Yes	Yes
Maximum allowable input current	50 mA for max. 30 sec	-
Input protection vs. surges <sup>8</sup>	Yes	Yes
Overvoltage protection	-	up to 30 VDC

8. Refer to Electromagnetic Compatibility section

9. The RGx1P is intended for use in closed loop systems where the output power automatically adjusts to the control input available from the system.

## Transfer Characteristics

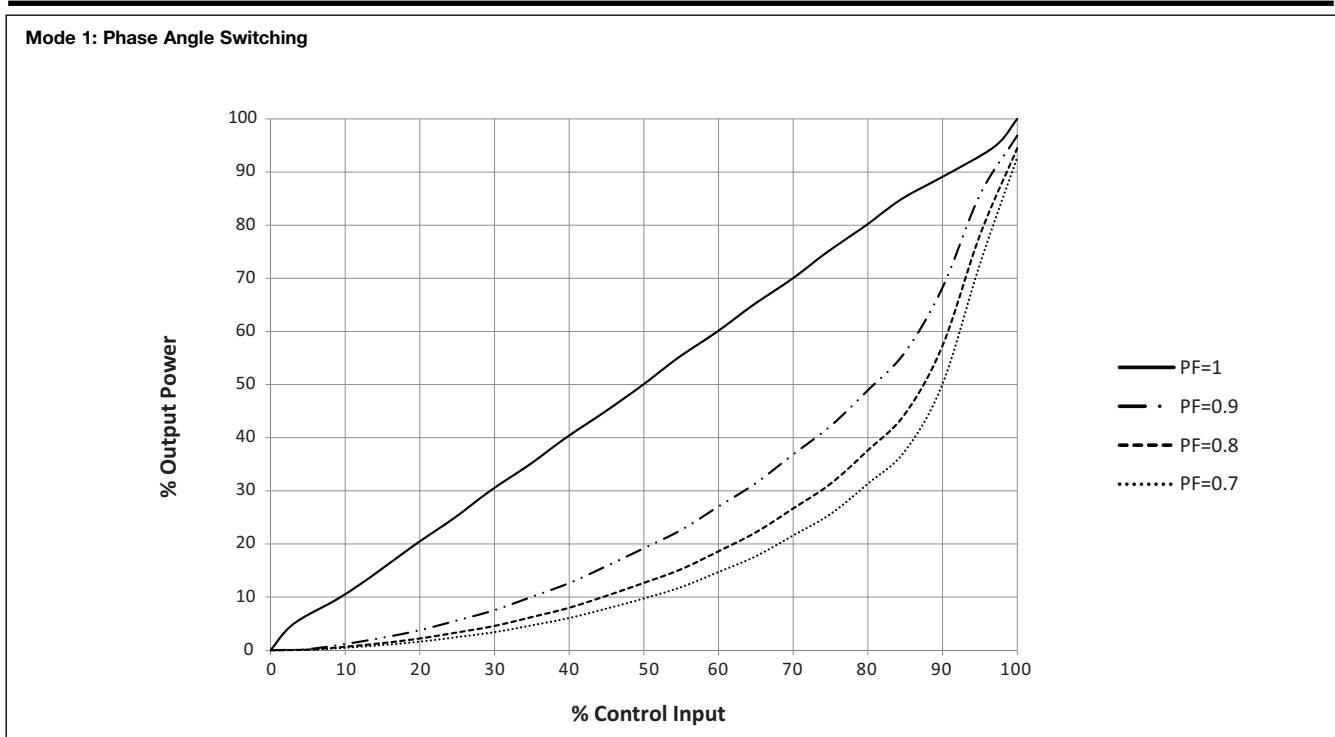

## Transfer Characteristics (cont.)

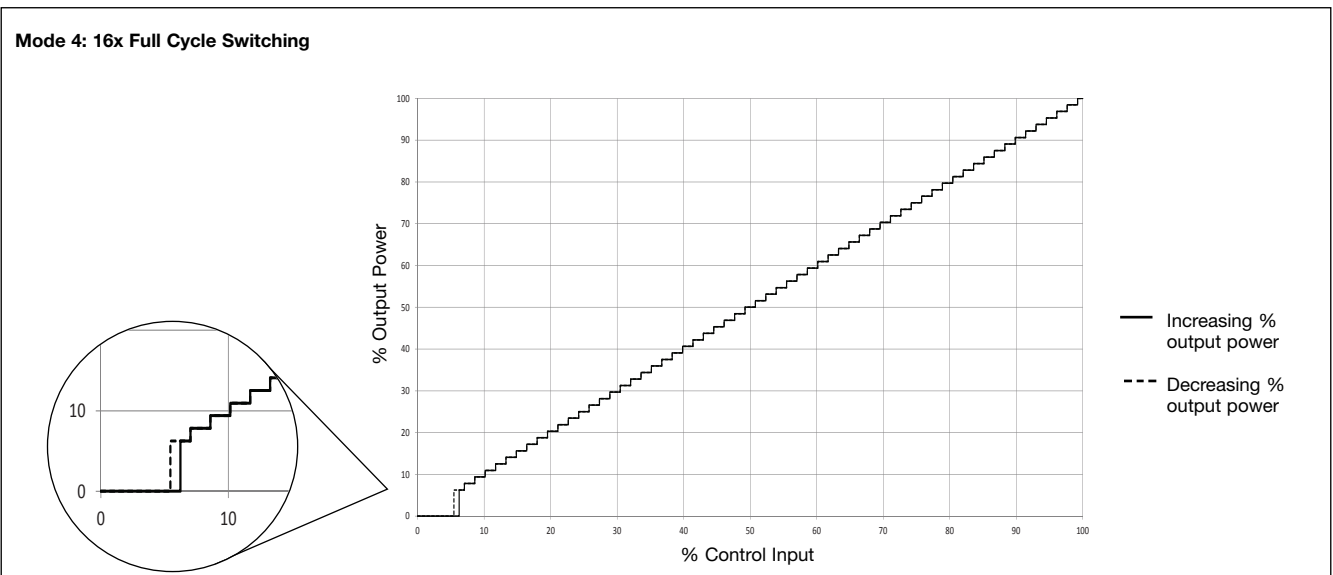
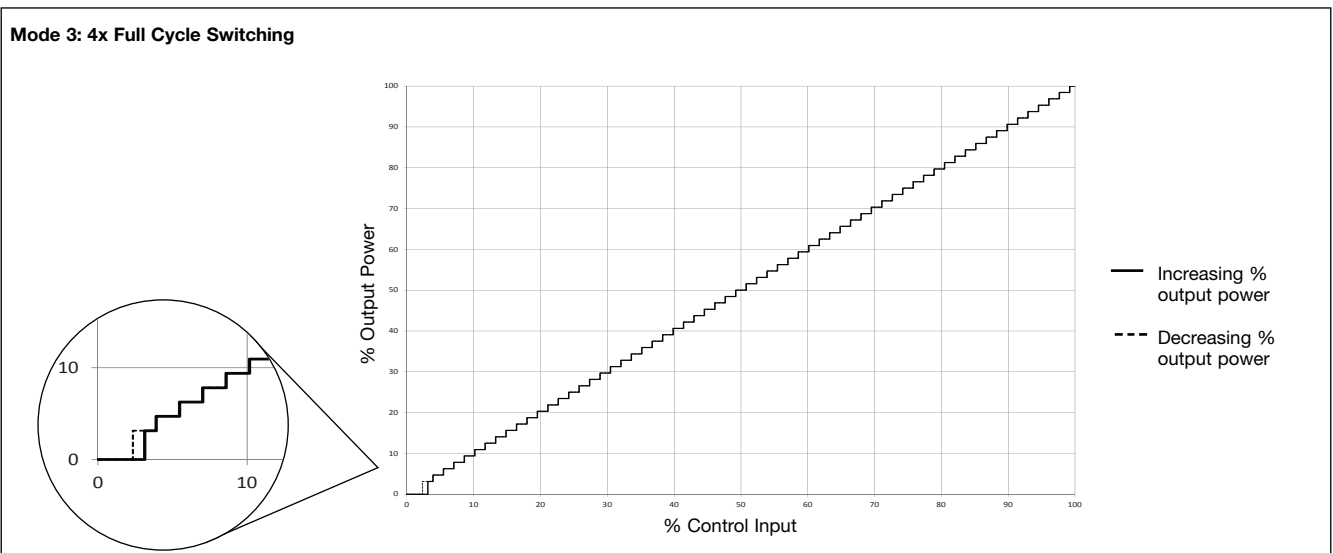
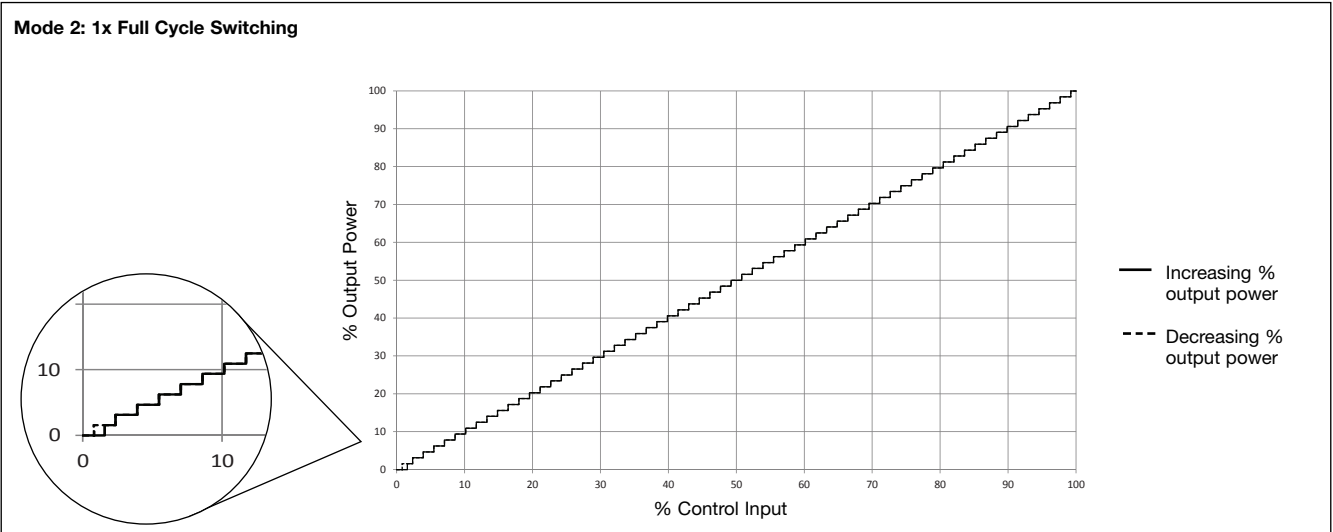

## Output Power Dissipation

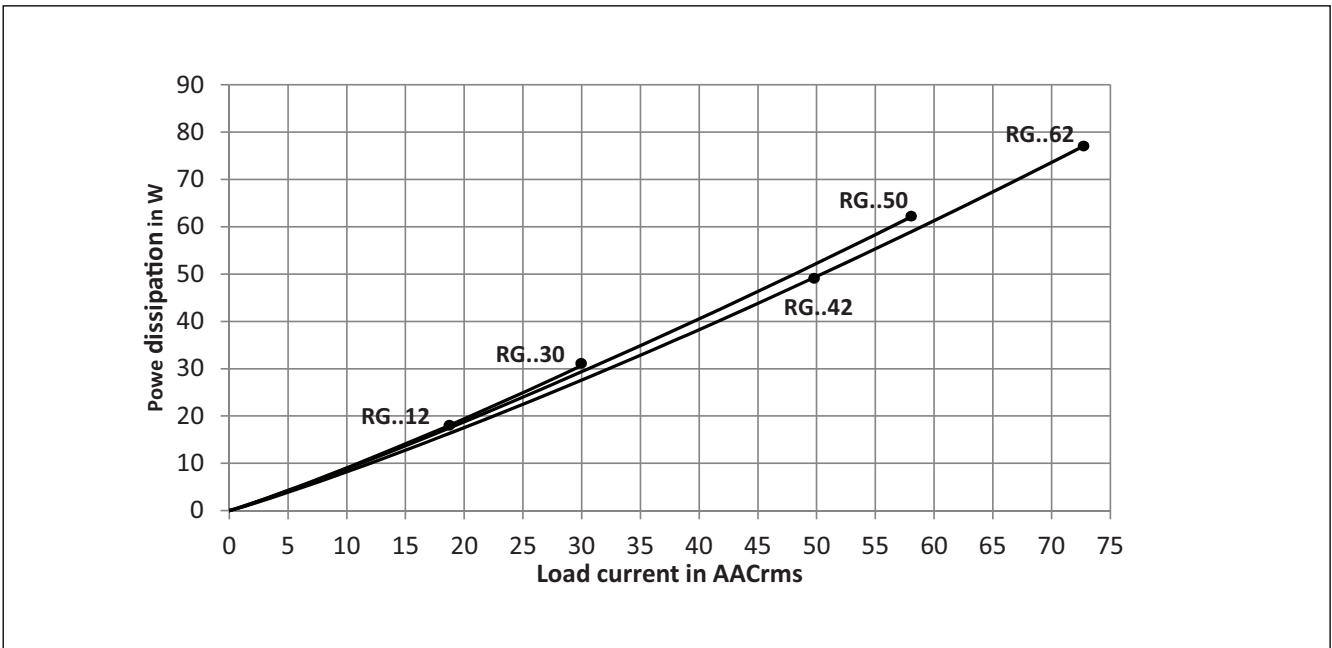

## Current Derating (UL 508)

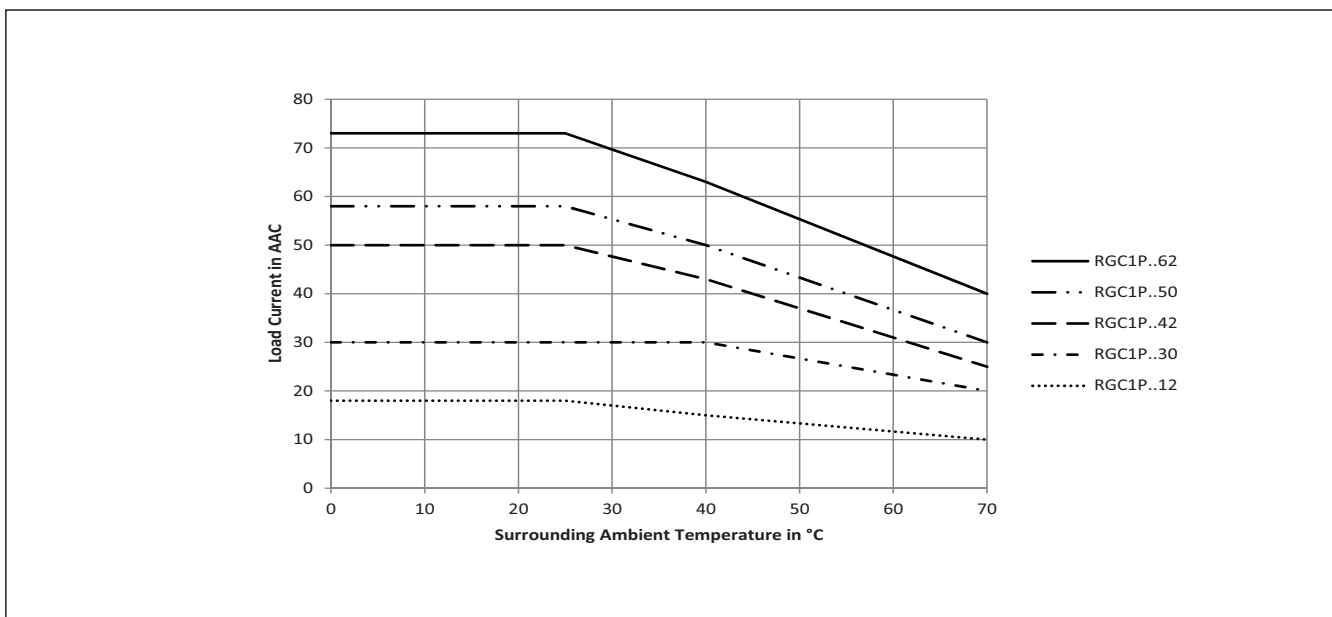

## Current Derating vs Spacing Curves

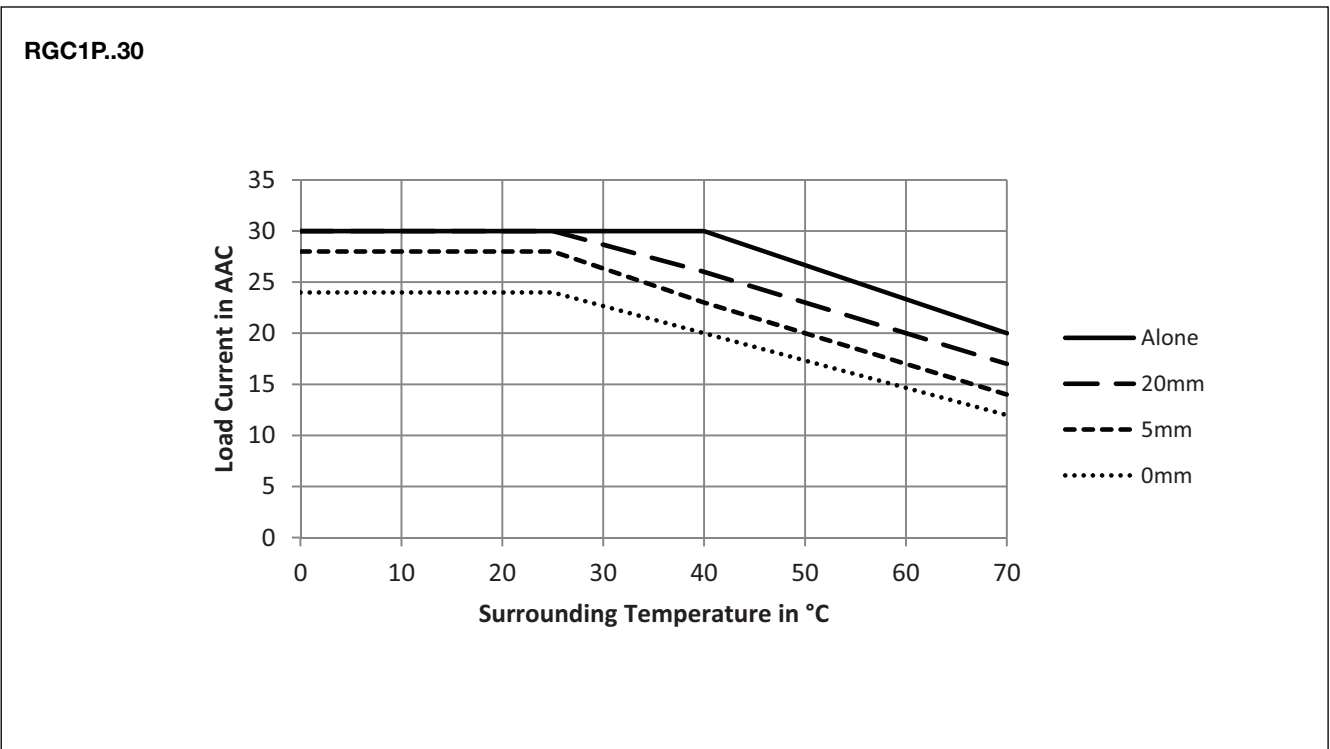
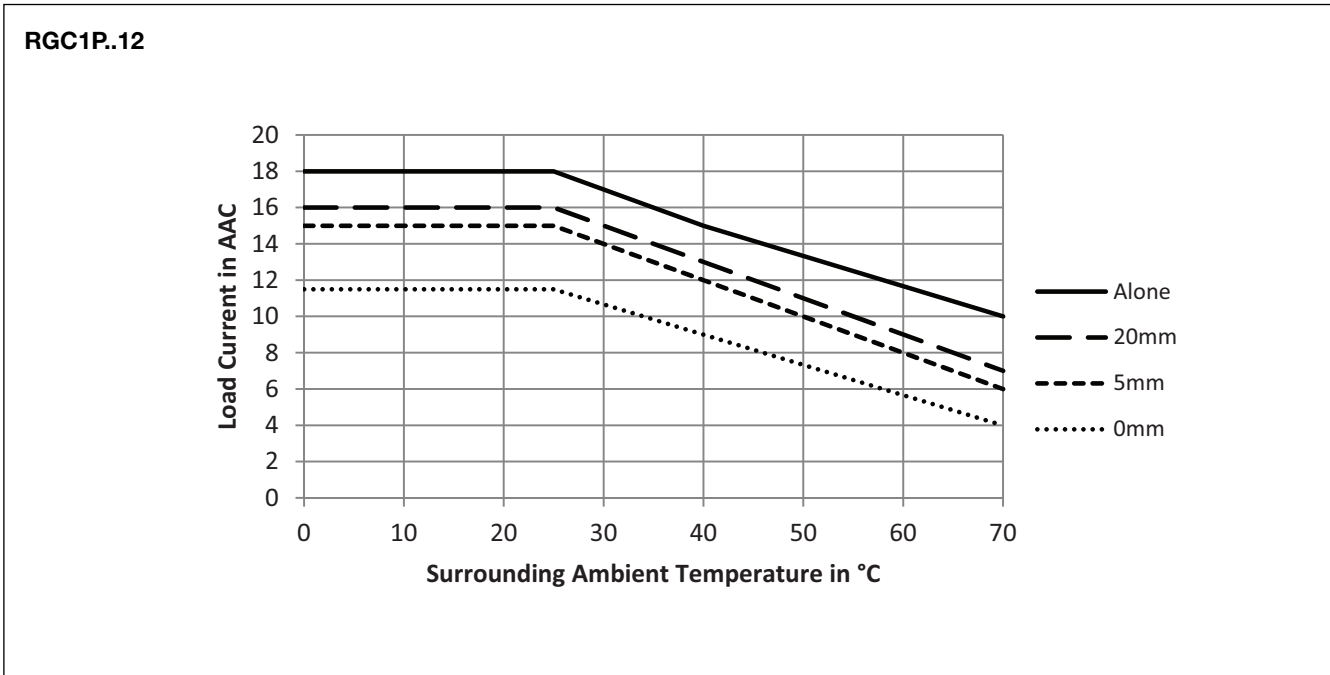

## Current Derating vs Spacing Curves

RGC1P.42

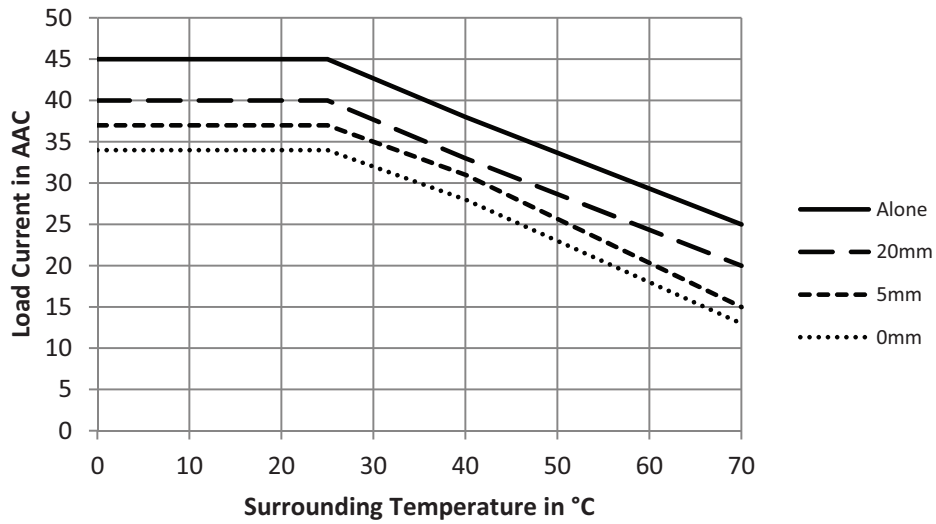

RGC1P.50

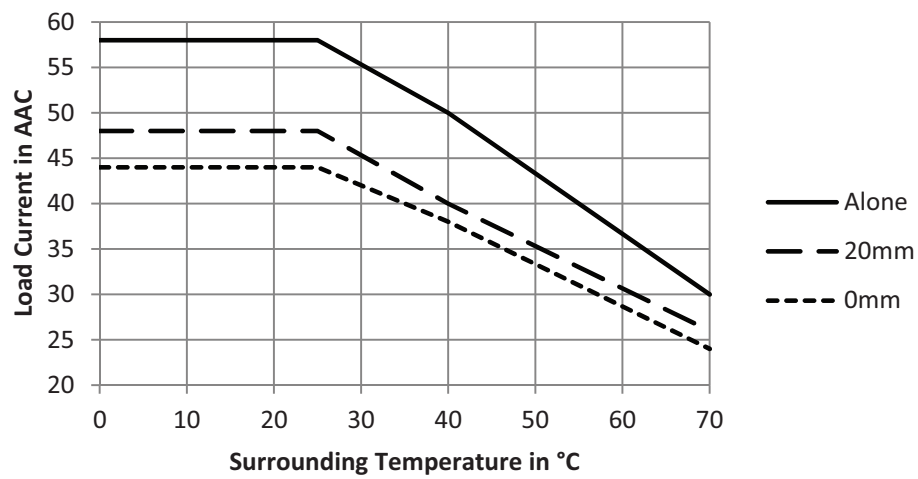



## Current Derating vs Spacing Curves

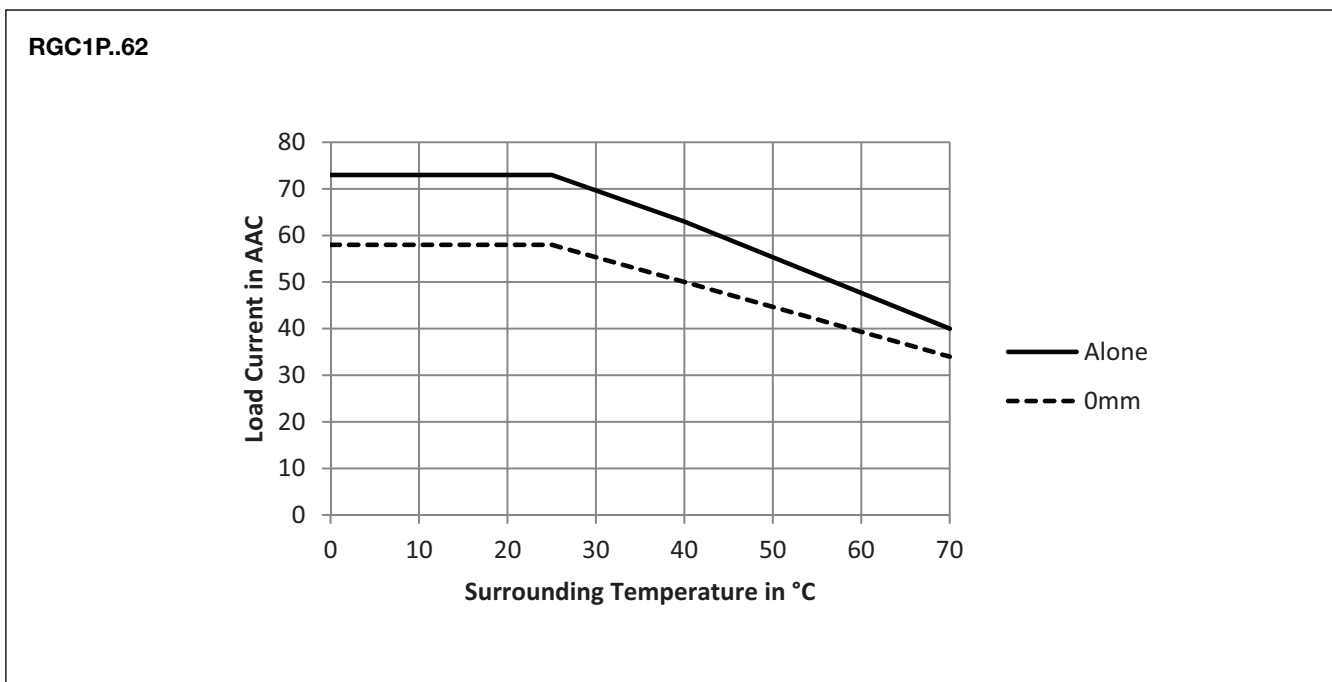

## Environmental and Housing Specifications

Operating Temperature	-40°C to +70°C (-40°F to +158°F)	UL flammability rating (for plastic)	UL 94 V0
Storage Temperature	-40°C to +100°C (-40°F to +212°F)	GWIT & GWFI (for plastic)	conform to EN 60335-1 requirements
RoHS (2011/65/EU)	Compliant	Installation altitude	0-1000m. Above 1000m derate linearly by 1% of FLC per 100m up to a maximum of 2000m
Impact resistance (EN50155, EN61373)	15/11 g/ms	Weight	
Vibration resistance (2-100Hz, EN50155, EN61373)	2g per axis	RGC1P..12	approx. 225g
Relative humidity	95% non-condensing @ 40°C	RGC1P..30, 42	approx. 460g
Material	PA66, RAL7035	RGC1P..50, 62	approx. 815g



## Agency Approvals and Conformances

<b>Conformance</b>	IEC/EN 60947-4-3	<b>Agency Approvals</b>	UL Listed: UL508, NMFT E172877 cUL Listed: CSA 22.2 No.14-13, NMFT7 E172877
 		<b>Short Circuit Current Rating</b>	100kArms, UL508

## Electromagnetic Compatibility

<b>EMC Immunity</b>	EN 60947-4-3	<b>Electrical fast transient (Burst) immunity</b>	EN/IEC 61000-4-4 Performance Criteria 1
<b>Electrostatic discharge (ESD) immunity</b>	EN/IEC 61000-4-2 Performance Criteria 2 Performance Criteria 2	Output: 2kV, 5 kHz <b>RGC1P..AA..</b> A1, A2: 2 kV, 5 kHz <b>RGC1P..V..</b> A1, A2, A3, POT, GND: 1 kV, 5 kHz Us: 2 kV, 5 kHz	Performance Criteria 1 Performance Criteria 1
<b>Electrical surge immunity</b>	EN/IEC 61000-4-5 Performance Criteria 2 Performance Criteria 2	<b>Radiated radio frequency immunity</b>	EN/IEC 61000-4-3 Performance Criteria 1 Performance Criteria 1 Performance Criteria 1
Output, line to line, 1 kV Output, line to earth, 2 kV A1, A2 <b>RGC1P..AA..</b> Line to line, 500 V Line to earth, 500 V A1, A2, A3, POT, GND <b>RGC1P..V..</b> Line to earth, 1 kV Us +, Us - <b>RGC1P..V..ED</b> Line to line, 500 V Line to earth, 500 V Us ~ <b>RGC1P..V..EA</b> Line to line, 1 kV Line to earth, 2 kV	Performance Criteria 2 Performance Criteria 2 Performance Criteria 2 Performance Criteria 2 Performance Criteria 2 Performance Criteria 2 Performance Criteria 2 Performance Criteria 2	10V/m, 80 - 1000 MHz 10V/m, 1.4 - 2.0 GHz 3V/m, 2.0 - 2.7 GHz	
<b>EMC Emission</b>	EN 60947-4-3	<b>Conducted radio frequency immunity</b>	EN/IEC 61000-4-6 Performance Criteria 1
<b>Radio interference voltage emission (conducted)</b>	EN/IEC 55011 Class A (with external filtering)	10V/m, 0.15 - 80 MHz	
0.15 - 30 MHz		<b>Voltage Dips</b>	EN/IEC 61000-4-11 Performance Criteria 2 Performance Criteria 2 Performance Criteria 2 Performance Criteria 2
		0% for 0.5, 1 cycle 40% for 10 cycles 70% for 25 cycles 80% for 250 cycles	
		<b>Voltage Interruptions</b>	EN/IEC 61000-4-11 Performance Criteria 2
		0% for 5000 ms	
		<b>Radio interference field emission (radiated)</b>	<b>EN/IEC 55011</b> Class A (industrial)
		30 - 1000 MHz	

Note:

- Control input lines must be installed together to maintain products susceptibility to Radio Frequency Interference.
  - Use of AC solid state relays may according to the application and the load current, cause conducted radio interferences. Use of mains filters may be necessary for cases where the user must meet E.M.C requirements. The capacitor values given inside the filtering specification tables should be taken only as indications, the filter attenuation will depend on the final application.
  - This product has been designed for Class A equipment. (External filtering may be required, refer to filtering section). Use of this product in domestic environments may cause radio interference, in which case the user may be required to employ additional mitigation methods.
  - Surge tests on RGC..A models were carried out with the signal line impedance network. In case the line impedance is less than 40Ω, it is suggested that AC supply is provided through a secondary circuit where the short circuit limit between conductors and ground is 1500VA or less.
  - A deviation of one step in the distributed full cycle models and up to 1.5% Full Scale Deviation in phase angle models is considered to be within PC1 criteria.
- Performance Criteria 1 (Performance Criteria A): No degradation of performance or loss of function is allowed when the product is operated as intended.  
 - Performance Criteria 2 (Performance Criteria B): During the test, degradation of performance or partial loss of function is allowed. However, when the test is complete the product should return operating as intended by itself.  
 - Performance Criteria 3 (Performance Criteria C): Temporary loss of function is allowed, provided the function can be restored by manual operation of the control.

## Filtering - EN/IEC 55011 Compliance

### Compliance to Class A emission limits

	RGC1P..12	RGC1P..30	RGC1P..42	RGC1P..50	RGC1P..62
<b>Max. Load Current</b>	<b>15 AAC</b>	<b>30 AAC</b>	<b>43 AAC</b>	<b>50 AAC</b>	<b>60 AAC</b>
	SCHURTER, 5500.2218	SCHAFFNER, FN2410-45-33	SCHAFFNER, FN2410-45-33	SCHAFFNER, FN2410-60-34	
<b>Mode 1 - Phase Angle</b>	ROXBURGH, RES90F16 RES90F20	EPCOS, SIFI -H-G136	A50R000 EPCOS, A42R122 SIFI-H-G136 (up to 36 AAC)	EPCOS, A50R000	SCHAFFNER, FN2410-60-34
<b>Mode 2 -1x Full Cycle</b>	1.0uF, max. 760 VAC / X1	2.2uF, max. 760 VAC / X1	3.3uF, max. 760 VAC / X1	3.3uF, max. 760 VAC / X1	3.3uF, max. 760 VAC / X1
<b>Mode 3 - 4x Full Cycle</b>	680nF, max. 760 VAC / X1	1uF, max. 760 VAC / X1	2.2uF, max. 760 VAC / X1	2.2uF, max. 760 VAC / X1	2.2uF, max. 760 VAC / X1
<b>Mode 4 - 16x Full Cycle</b>	330nF, max. 760 VAC / X1	680nF, max. 760 VAC / X1	1uF, max. 760 VAC / X1	1uF, max. 760 VAC / X1	2.2uF, max. 760 VAC / X1
<b>Mode 5 - Advanced full cycle</b>	1.0uF, max. 760 VAC / X1	3.3uF, max. 760 VAC / X1	3.3uF, max. 760 VAC / X1	3.3uF, max. 760 VAC / X1	SCHAFFNER, FN2410-60-34 EPCOS, A60R000
<b>Mode 6 - Soft start + Mode 4</b>	330nF, max. 760 VAC / X1	680nF, max. 760 VAC / X1	1uF, max. 760 VAC / X1	1uF, max. 760 VAC / X1	2.2uF, max. 760 VAC / X1
<b>Mode 7 - Soft start + Mode 5</b>	1.0uF, max. 760 VAC / X1	3.3uF, max. 760 VAC / X1	3.3uF, max. 760 VAC / X1	3.3uF, max. 760 VAC / X1	SCHAFFNER, FN2410-60-34 EPCOS, A60R000

### Compliance to Class B emission limits

	RGC1P..12	RGC1P..30	RGC1P..42	RGC1P..50	RGC1P..62
<b>Max. Load Current</b>	<b>15 AAC</b>	<b>30 AAC 43 AAC</b>	<b>50 AAC</b>	<b>60 AAC</b>	
	SCHURTER, 5500.2069 (up to 12 AAC)				
<b>Mode 1 - Phase Angle</b>	SIFI-H-G120 EPCOS, B12R000 (up to 12 AAC)	EPCOS, A42R1122	EPCOS, A55R122	EPCOS, A55R122	EPCOS, A75R122
		SCHAFFNER, FN2410-45-33	SCHAFFNER, FN2410-45-33	SCHAFFNER, FN2410-60-34	SCHAFFNER, FN2410-60-34
<b>Mode 2 - 1x Full Cycle</b>	3.3uF, max. 760 VAC / X1	EPCOS, SIFI-H-G136	ROXBURGH, MDF50 A50R000 A42R122 EPCOS, SIFI-H-G136 (up to 36 AAC)	ROXBURGH, MDF50 A55R122 EPCOS, A42R122 (up to 42 AAC)	EPCOS, A60R000
				SCHAFFNER, FN2410-60-34	SCHAFFNER, FN2410-60-34
<b>Mode 3 - 4x Full Cycle</b>	2.2uF, max. 760 VAC / X1	3.3uF, max. 760 VAC / X1	3.3uF, max. 760 VAC / X1	EPCOS, A42R122 (up to 42 AAC)	EPCOS, A60R000
<b>Mode 4 - 16x Full Cycle</b>	1.0uF, max. 760 VAC / X1	2.2uF, max. 760 VAC / X1	2.2uF, max. 760 VAC / X1	3.3uF, max. 760 VAC / X1	3.3uF, max. 760 VAC / X1
	SCHURTER, 5500.2218	SCHAFFNER, FN2410-45-33	SCHAFFNER, FN2410-45-33	SCHAFFNER, FN2410-60-34	SCHAFFNER, FN2410-60-34
<b>Mode 5 - Advanced full cycle</b>	ROXBURGH, RES90F16 RES90F20	EPCOS, SIFI-H-G136	ROXBURGH, MDF50 A50R000 A42R122 EPCOS, SIFI-H-G136 (up to 36 AAC)	ROXBURGH, MDF50 A55R122 EPCOS, A42R122 (up to 42 AAC)	EPCOS, A60R000
<b>Mode 6 - Soft start + Mode 4</b>	1.0uF, max. 760 VAC / X1	2.2uF, max. 760 VAC / X1	2.2uF, max. 760 VAC / X1	3.3uF, max. 760 VAC / X1	3.3uF, max. 760 VAC / X1
	SCHURTER, 5500.2218	SCHAFFNER, FN2410-45-33	SCHAFFNER, FN2410-45-33	SCHAFFNER, FN2410-60-34	SCHAFFNER, FN2410-60-34
<b>Mode 7 - Soft start + Mode 5</b>	ROXBURGH, RES90F16 RES90F20	EPCOS, SIFI-H-G136	ROXBURGH, MDF50 A50R000 A42R122 EPCOS, SIFI-H-G136 (up to 36 AAC)	ROXBURGH, MDF50 A55R122 EPCOS, A42R122 (up to 42 AAC)	EPCOS, A60R000

## Filter Connection Diagram

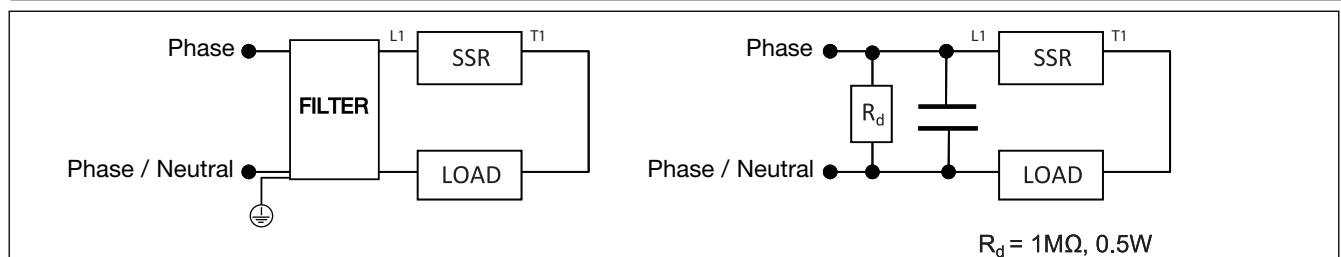

Note: The suggested filtering is determined by tests carried out on a representative setup and load. The RGC1P. is intended to be integrated within a system where conditions may differentiate from conditions utilised for tests, such as load, cable lengths and other auxiliary components that may exist within the end system. It shall be the responsibility of the system integrator to ensure that the system containing the above component complies with the applicable rules and regulations.

Filter manufacturer installation recommendations shall be taken in consideration when utilising such filters.

## Product Interface

### RGC1P..AA..

**Terminals Labelling:**

1/L1: Line connection  
 2/T1: Load connection  
 A1 - A2: Control input: 4 - 20 mA

### RGC1P..V..

**Terminals Labelling:**

1/L1: Line connection  
 2/T1: Load connection  
 A1-GND: Control input: 0-10V  
 A2-GND: Control input: 0-5V  
 A3-GND: Control input: 1-5V  
 POT: External potentiometer input  
 Us (+, -): External supply, positive signal (RG..V.D) or AC signal (RG..V.A)  
 Us (-, -): External supply, ground (RG..V.D) or AC signal (RG..V.A)

Ramp up time setting for soft starting, applicable for Modes 6 and 7 only

Mode Selection	Switching Mode
	<b>1</b> Phase Angle (default setting)
	<b>2</b> 1x Full Cycle
	<b>3</b> 4x Full Cycles
	<b>4</b> 16x Full Cycles
	<b>5</b> Advanced Full Cycle
	<b>6</b> Soft start + 16x Full Cycles
	<b>7</b> Soft start + Advanced Full Cycle

## LED Indications

### RGC1P..AA..

LED	Status	Timing Diagram
CONTROL (green)	Control input <4mA	[Pulsed signal]
	Control input >4mA	[Solid signal]
	Mains loss	[Pulsed signal with 0.5s interval]
	SSR internal error	[Pulsed signal with 0.5s interval and 3s delay]
LOAD (yellow)	LOAD ON	[Solid signal]

### RGC1P..V..

LED	Status	Timing Diagram
CONTROL (green)	Supply voltage (Us) ON	[Pulsed signal]
	Control input >0V	[Solid signal]
	Mains loss	[Pulsed signal with 0.5s interval]
	SSR internal error	[Pulsed signal with 0.5s interval and 3s delay]
LOAD (yellow)	LOAD ON	[Solid signal]

## Switching Modes



### MODE 1: Phase angle switching

The Phase angle switching mode works in accordance with the phase angle control principle. The power delivered to the load is controlled by the firing of the thyristors over each half mains cycle. The firing angle depends on the input signal level that determines the output power to be delivered to the load.

Output with Phase angle switching mode @ 50% input level:

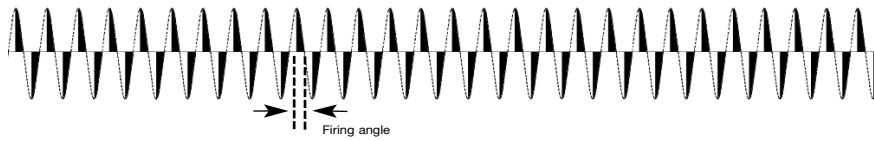

### Full cycle switching

In Full cycle switching modes only full cycles are being switched. Switching at zero voltage reduces EMC interference as compared to phase angle switching (mode 1). The ON full cycles are distributed over a specific time base. Compared to burst firing, this enables faster and more accurate control of the load in addition to extending the heater lifetime. This mode is suitable for use only with resistive loads.

### MODE 2: 1x Full cycle switching

This mode offers the lowest resolution for full cycle switching, i.e., 1 full cycle. At 50% output power demand the SSR will switch ON the load for 1 full cycle and OFF for 1 full cycle in a repeated pattern. Below 50% output power demand, the non-firing period increases but the firing period remains fixed at 1 full cycle. Over 50% output power demand, the firing period increases but the non-firing period remains fixed at 1 full cycle.

Hence at 25% output power demand, the non-firing period gets longer and the SSR will switch ON the load for 1 full cycle and OFF for 3 full cycles in a repeated pattern. At 75% output power demand, the firing period is longer and the SSR will switch ON the load for 3 full cycles and OFF for 1 full cycle in a repeated pattern. At 100% output power demand, the SSR switches the load fully ON.

Output with 1 FC switching mode @ 25% input level:



Output with 1 FC switching mode @ 50% input level:



Output with 1 FC switching mode @ 75% input level:



Output with 1 FC switching mode @ 100% input level:

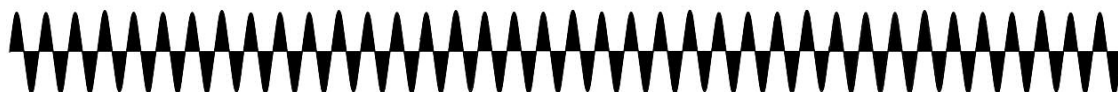

## Switching Modes

### MODE 3: 4x Full cycle switching

### MODE 4: 16x Full cycle switching

In **mode 3** the minimum resolution is 4 full cycles. At 50% output power demand the SSR will switch ON the load for 4 full cycles and OFF for 4 full cycles in a repeated pattern. Below 50% output power demand, the non-firing period increases but the firing period remains fixed at 4 full cycles. Over 50% output power demand, the firing period increases but the non-firing period remains fixed at 4 full cycles.

In **mode 4** the minimum resolution is 16 full cycles. At 50% output power demand the SSR will switch ON the load for 16 full cycles and OFF for 16 full cycles in a repeated pattern. Below 50% output power demand, the non-firing period increase but the firing period remains fixed at 16 full cycles. Over 50% output power demand the firing period increases but the non-firing period remains fixed at 16 full cycles.

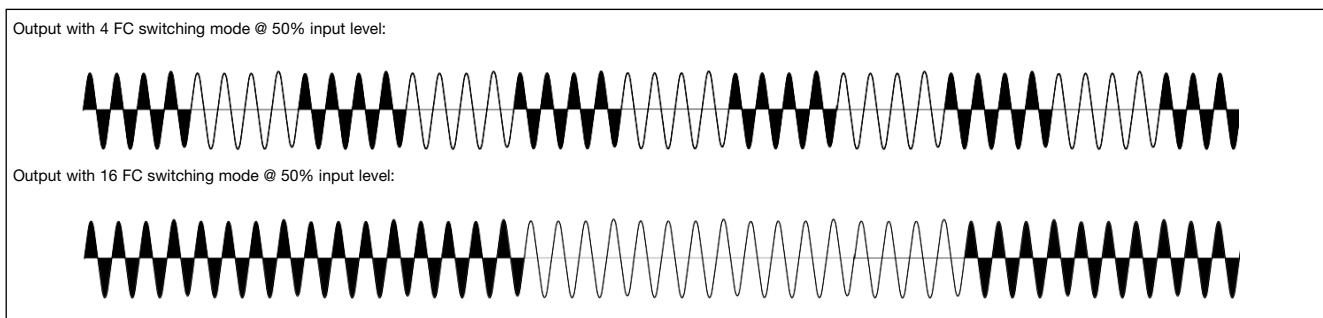

### MODE 5: Advanced Full Cycle (AFC) switching

This switching mode is based on the principle of distributed full cycle explained above with the difference that the resolution for firing and non-firing periods is changed to a half mains cycle. This mode is intended for use with short / medium wave infrared heaters. The purpose of the half cycle non-firing time is to reduce the annoying visual flickering of such lamp loads.

Below 50% output power demand, the SSR switches ON the load in half cycle periods. The non-firing periods are full cycles. Above 50% output power demand, the SSR switches ON the load in full cycle periods but the non-firing periods are half cycles.

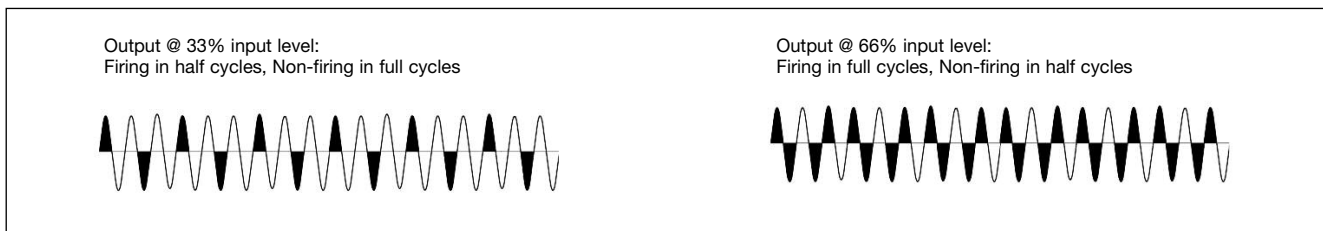

### SOFT STARTING

Soft starting is utilised to reduce the start-up current of loads having a high cold to hot resistance ratio such as short wave infrared heaters. The thyristor firing angle is gradually increased over a time period of maximum 5 seconds (settable through an accessible potentiometer) in order to apply the voltage (and current) to the load smoothly.

Soft starting is performed on the first power up and in cases of non firing periods exceeding 5 seconds. If soft start is stopped before soft start completion, it is assumed that a start was performed and the non firing period count start as soon as the soft start is stopped.

## Switching Modes

### MODE 6: Soft start + MODE 4 (16x full cycle switching)

This switching mode works on the principle of switching mode 4 (16x full cycles) but soft starting is performed on power up or in case of the non firing periods exceeding 5 seconds. After the soft start is completed, full cycles (with a resolution of 16 full cycles) are delivered to the load according to the input signal, based on MODE 4 switching principle.

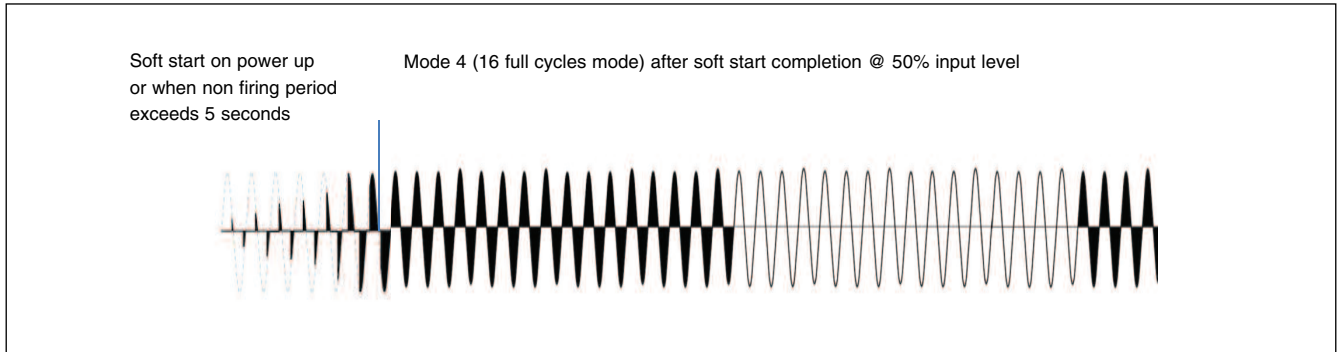

### MODE 7: Soft start + MODE 5 (Advanced full cycle switching)

This switching mode works on the principle of the advanced full cycle (mode 5) but soft starting is performed on power up or in case of the non firing periods exceeding 5 seconds. After the soft start is completed, output power is delivered to the load according to the input signal, based on Mode 5 switching principle.

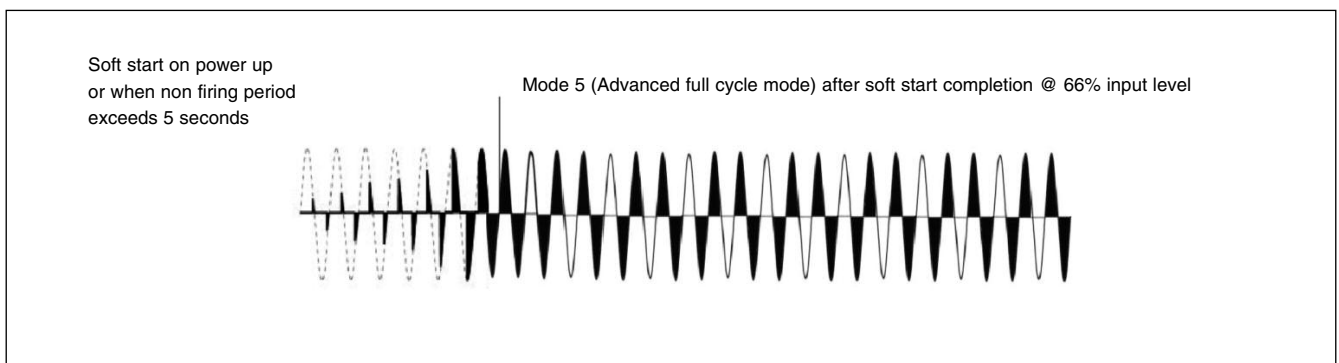

## Dimensions

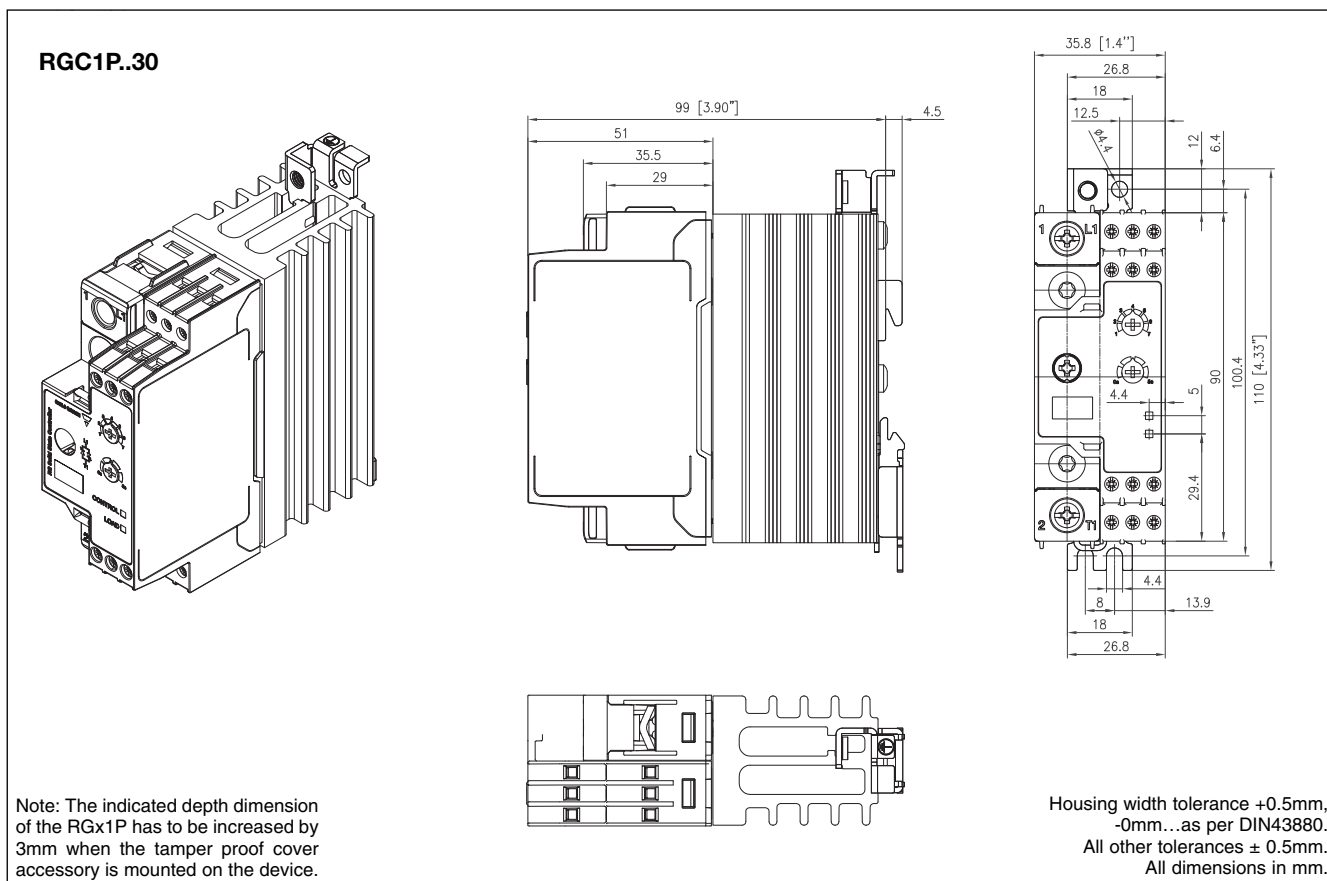
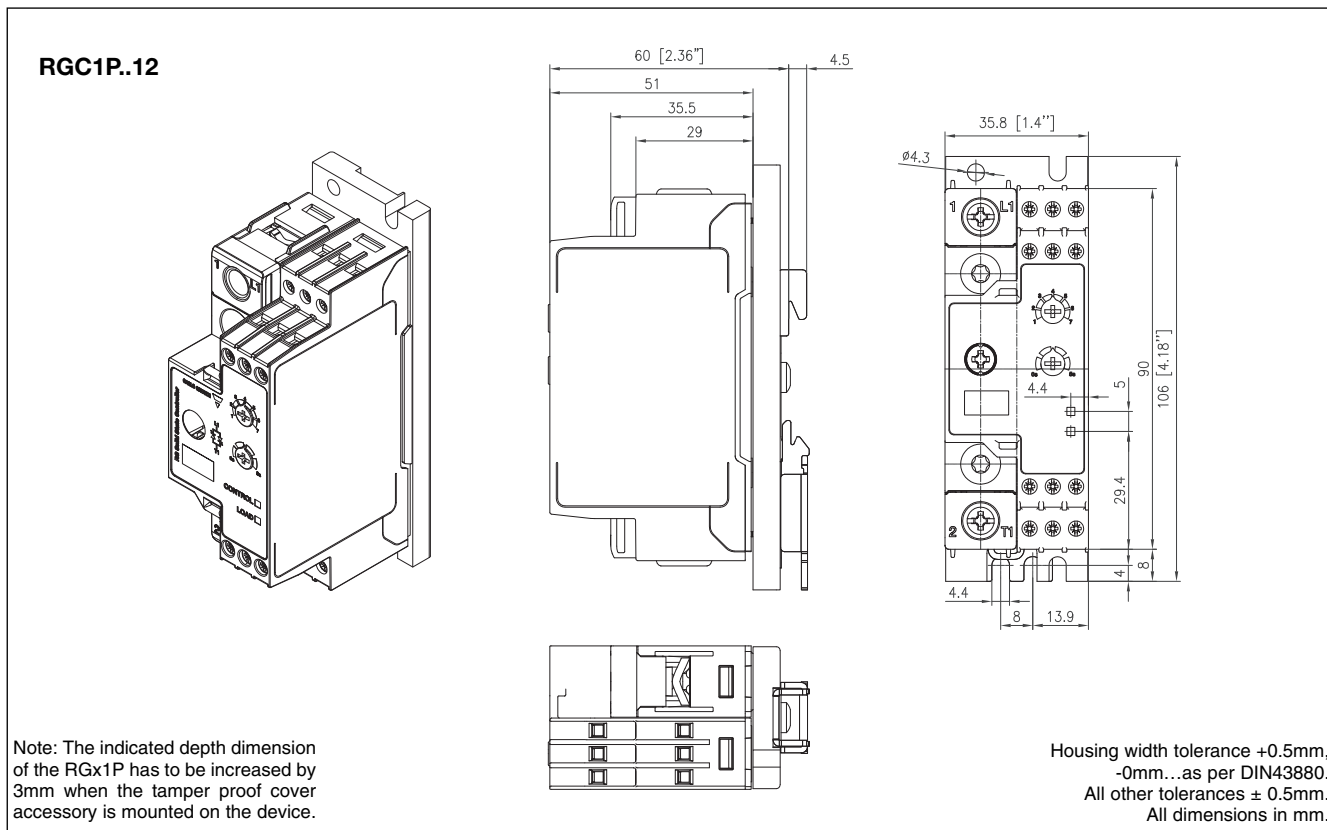





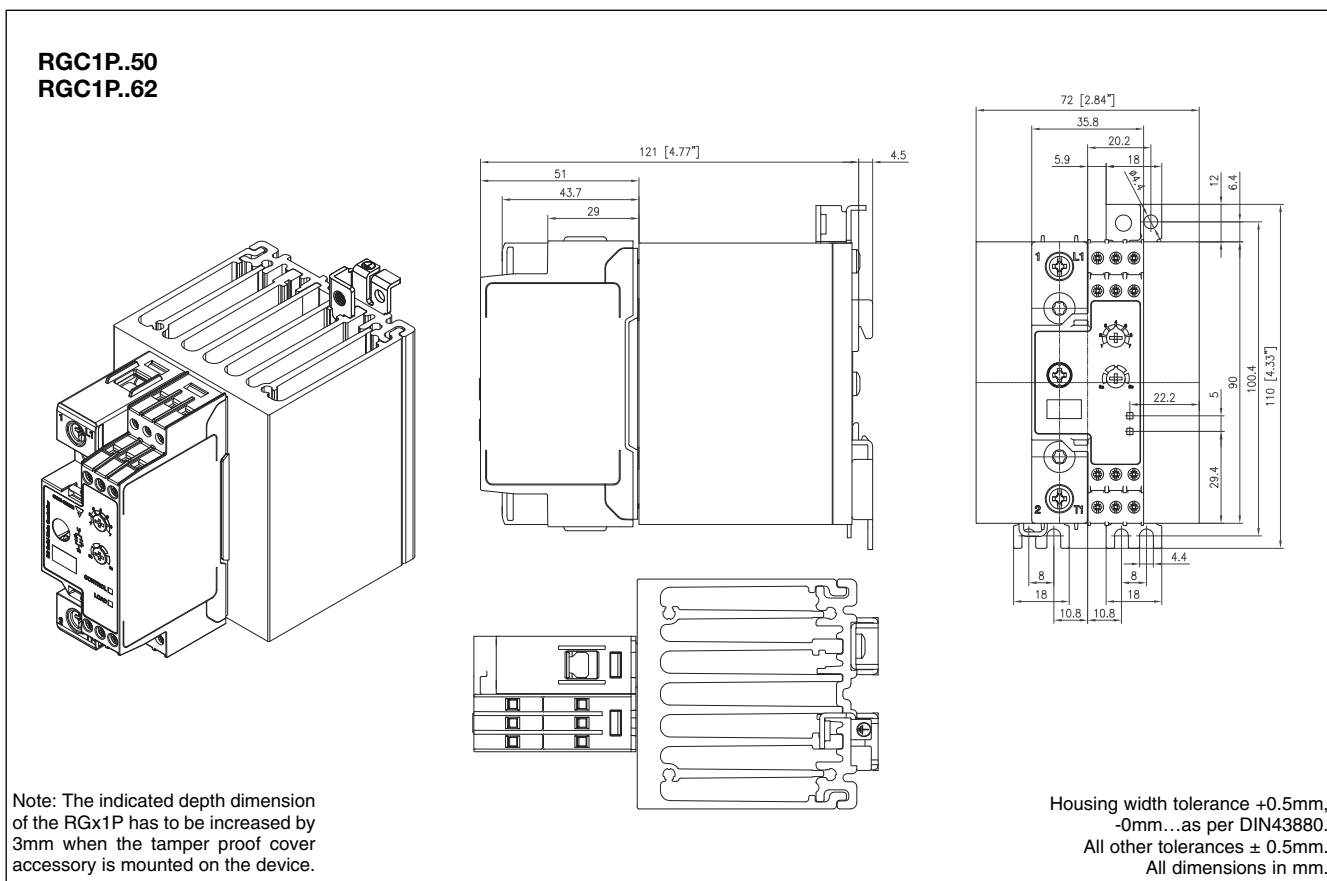
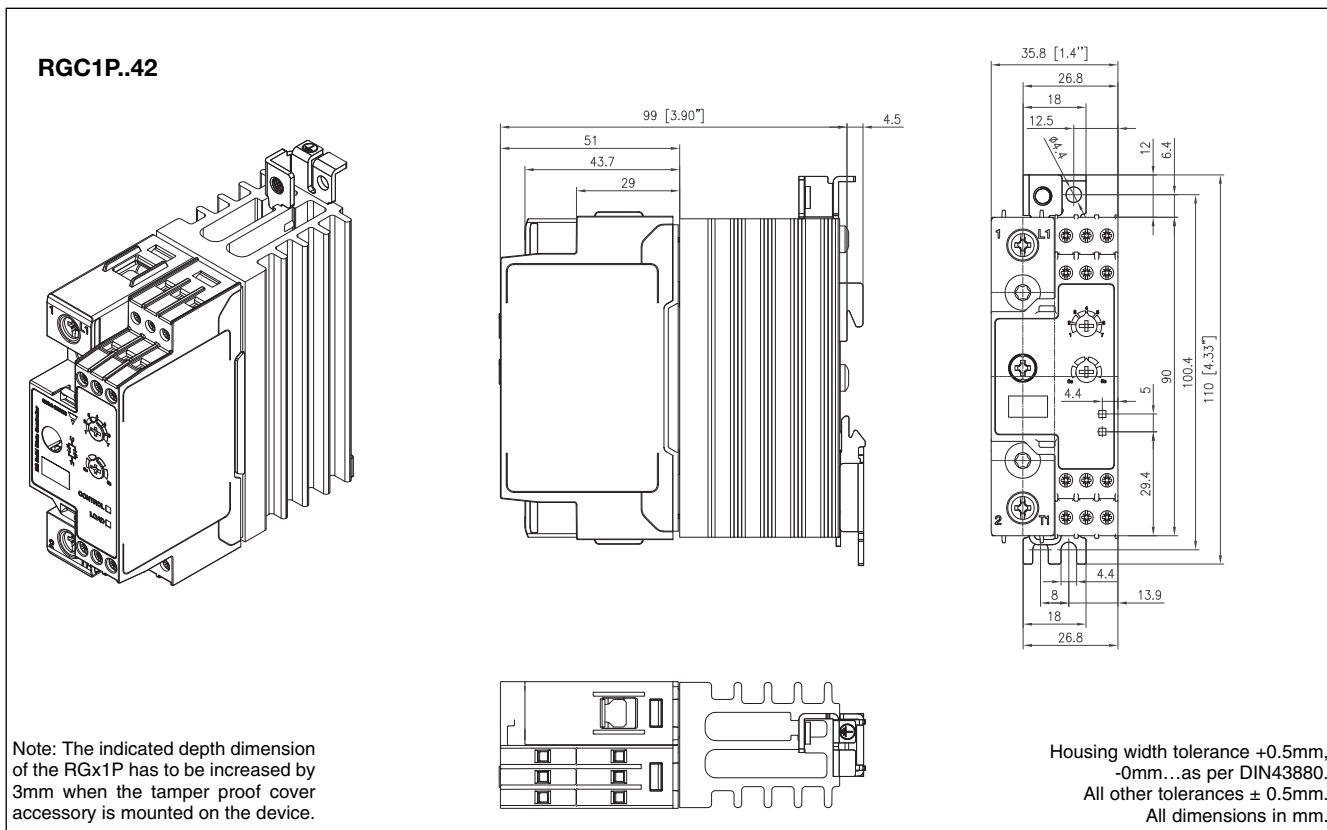



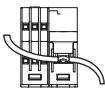

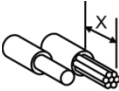
## Dimensions



## Connection Specifications

<b>POWER CONNECTIONS</b>		1/L1, 2/T1		
Use 75°C copper (Cu) conductors		RGC..12, RGC..30		RGC..42, RGC..50, RGC..62
Stripping length (X)		12mm 		11mm 
Connection type		M4 screw with captivated washer		M5 screw with box clamp
Rigid (solid & stranded)		2x 2.5 - 6.0 mm <sup>2</sup>	1x 2.5 - 6.0 mm <sup>2</sup>	1x 2.5 - 25 mm <sup>2</sup>
UL/cUL rated data		2x 14 - 10 AWG	1x 14 - 10 AWG	1x 14 - 3 AWG
Flexible with end sleeve		2x 1.0 - 2.5 mm <sup>2</sup> 2x 2.5 - 4.0 mm <sup>2</sup> 2x 18 - 14 AWG 2x 14 - 12 AWG	1x 1.0 - 4.0 mm <sup>2</sup> 1x 18 - 12 AWG	1x 2.5 - 16 mm <sup>2</sup> 1x 14 - 6 AWG
Flexible without end sleeve		2x 1.0 - 2.5 mm <sup>2</sup> 2x 2.5 - 6.0 mm <sup>2</sup> 2x 18 - 14 AWG 2x 14 - 10 AWG	1x 1.0 - 6.0 mm <sup>2</sup> 1x 18 - 10 AWG	1x 4.0 - 25 mm <sup>2</sup> 1x 12 - 3 AWG
Torque specification		Pozidriv 2 UL: 2Nm (17.7 lb-in) IEC: 1.5-2.0Nm (13.3-17.7 lb-in)		Pozidriv 2 UL: 2.5Nm (22 lb-in) IEC: 2.5-3.0Nm (22-26.6 lb-in)
Aperture for termination lug		12.3mm		n/a



Protective Earth (PE) connection   M5, 1.5Nm (13.3 lb-in)  
Not provided with SSR. PE connection required when product is intended to be used in Class 1 applications according to EN/IEC 61140

### CONTROL CONNECTIONS

Use 60/ 75°C copper (Cu) conductors

GND, A1, A2, A3, POT, Us

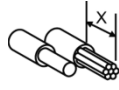

Stripping length (X)		8 mm		
Connection type		M3 screw with box clamp		
Rigid (solid & stranded)		1x 1.0 - 2.5 mm <sup>2</sup> 1x 18 - 12 AWG		
UL/cUL rated data				
Flexible with end sleeve		1x 0.5 - 2.5 mm <sup>2</sup> 1x 20 - 12 AWG		
Torque specification		Pozidriv 1 UL: 0.5Nm (4.4 lb-in) IEC: 0.4-0.5Nm (3.5-4.4 lb-in)		

# Connection Diagram

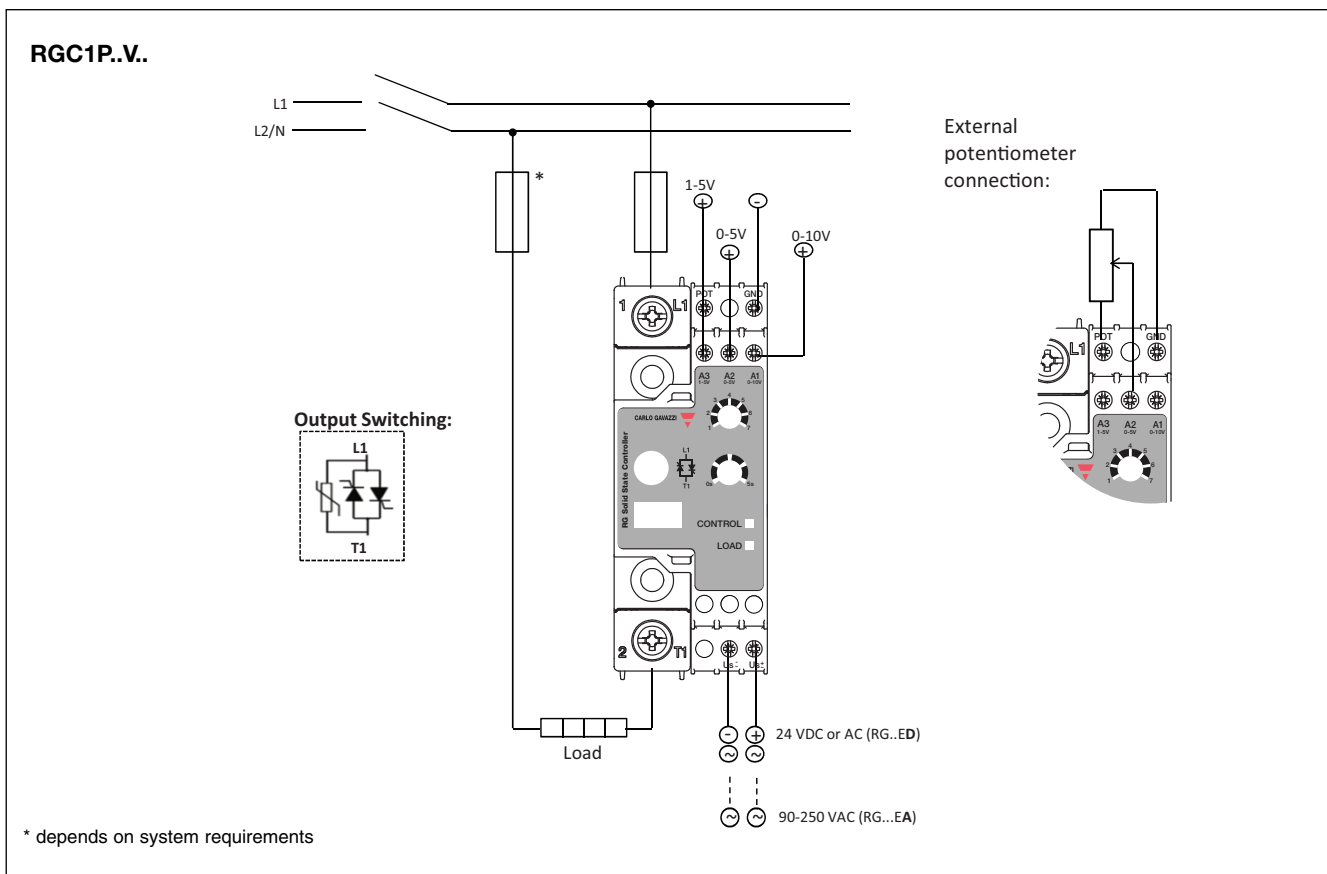
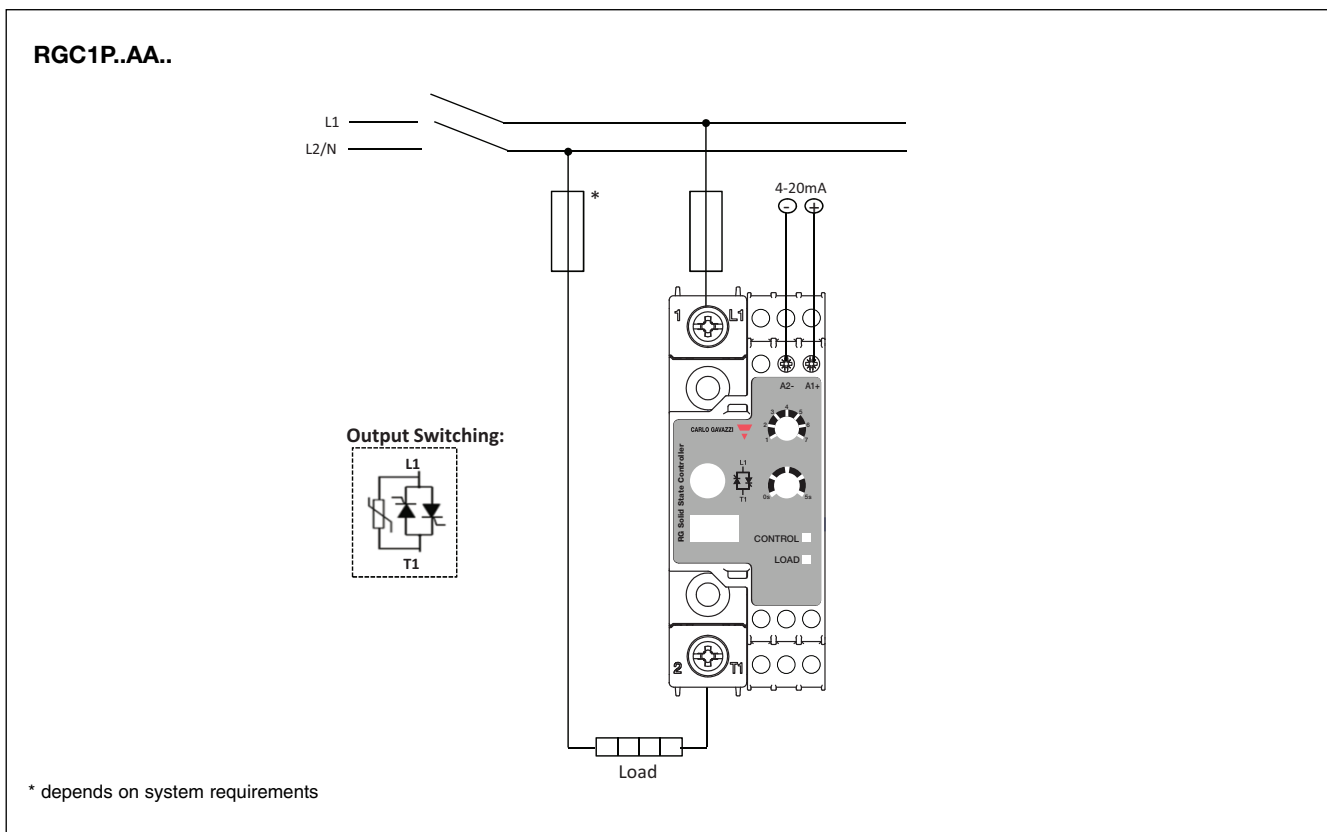

## Mounting Instructions

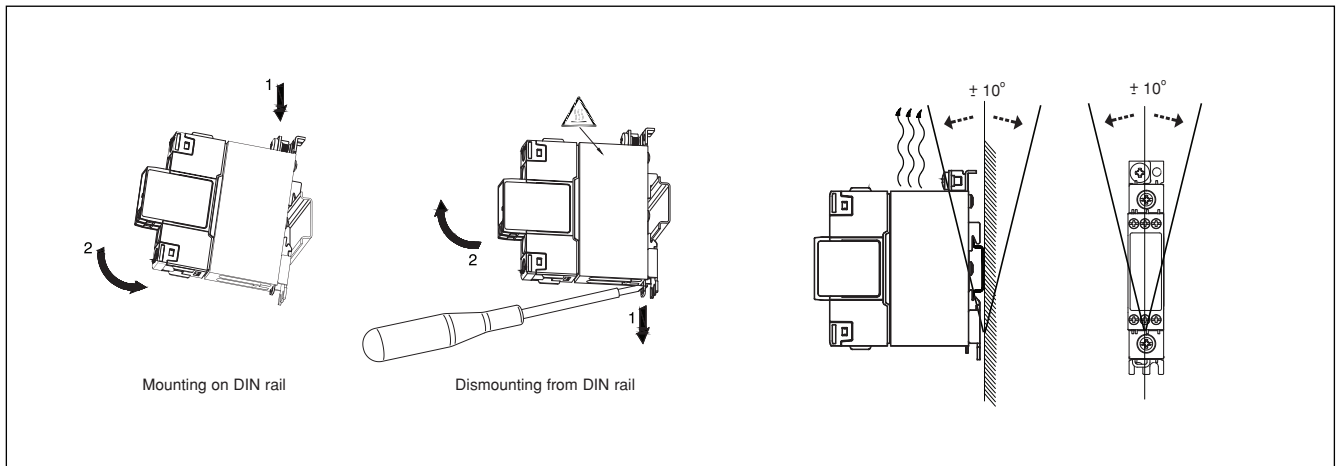

## Installation Instructions

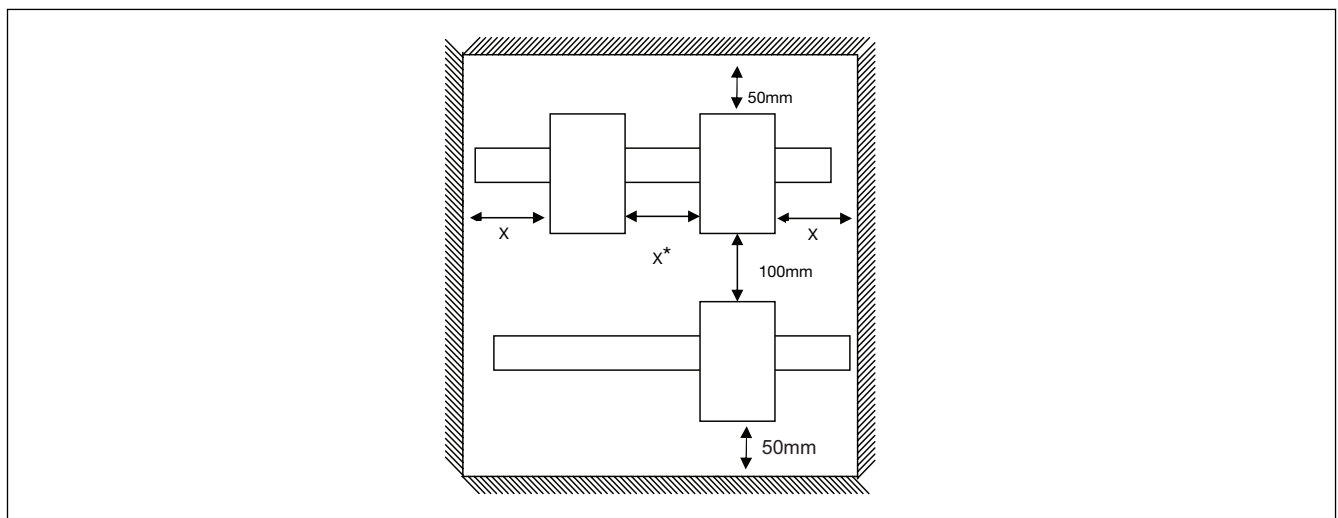

\* Refer to Current Derating vs spacing curves. Spacing between SSR and panel walls should be >5mm.

## Short Circuit Protection

### Protection Co-ordination, Type 1 vs Type 2:

Type 1 protection implies that after a short circuit, the device under test will no longer be in a functioning state. In type 2 co-ordination the device under test will still be functional after the short circuit. In both cases, however the short circuit has to be interrupted. The fuse between enclosure and supply shall not open. The door or cover of the enclosure shall not be blown open. There shall be no damage to conductors or terminals and the conductors shall not separate from terminals. There shall be no breakage or cracking of insulating bases to the extent that the integrity of the mounting of live parts is impaired. Discharge of parts or any risk of fire shall not occur.

The product variants listed in the table hereunder are suitable for use on a circuit capable of delivering not more than 100,000A Symmetrical Amperes, 600Volts maximum when protected by fuses. Tests at 100,000Arms were performed with Class J fuses, fast acting; please refer to the tables below for maximum ratings. Tests with Class J fuses are representative of Class CC fuses.

### Co-ordination type 1 (UL508)

Part No.	Short circuit current [kArms]	Max. fuse size [A]	Class	Voltage [VAC]
RGC1P..12	100	30	J or CC	Max. 600
RGC1P..30	100	30	J or CC	Max. 600
RGC1P..42	100	80	J	Max. 600
RGC1P..50	100	30	J	Max. 600
RGC1P..62	100	80	J	Max. 600

### Co-ordination type 2 (EN/IEC 60947-4-3)

Part No.	Short circuit current [kArms]	Ferraz Shawmut (Mersen)		Siba		Voltage [VAC]
		Max. fuse size [A]	Part No.	Max. fuse size [A]	Part No.	
RGC1P..12 RGC1P..30	10	40	6.9xx CP GRC 22x58 /40	32	50 142 06.32	Max. 600
	100	40	6.9xx CP URD 22x58 /40	32	50 142 06.32	Max. 600
RGC1P..42	10	63	6.9xx CP URC 14x51 /63	80	50 142 20.80	Max. 600
	10	70	A70QS70-4	80	50 142 20.80	Max. 600
	100	63	6.9xx CP URC 14x51 /63	80	50 142 20.80	Max. 600
	100	70	A70QS70-4	80	50 142 20.80	Max. 600
RGC1P..50	10	80	6.621 CP URQ 27x60 /80	80	50 142 20.80	Max. 600
	100	n/a	n/a	80	50 142 20.80	Max. 600
RGC1P..62	10	100	6.9xx CP GRC 22x58 /100	100	50 142 20.100	Max. 600
	10	100	A70QS100-4	100	50 142 20.100	Max. 600
	100	100	6.621 CP URGD 27x60 /100	100	50 142 20.100	Max. 600
	100	100	A70QS100-4	100	50 142 20.100	Max. 600

xx = 00, without fuse trip indication

xx = 21, with fuse trip indication

## Type 2 Protection with Miniature Circuit Breakers (M.C.B.s)

Solid State Relay type	ABB Model no. for Z - type M. C. B. (rated current)	ABB Model no. for B - type M. C. B. (rated current)	Wire cross sectional area [mm <sup>2</sup> ]	Minimum length of Cu wire conductor [m] <sup>10</sup>
RGC1P..12 RGC1P..30	<b>1 pole</b> S201 - Z10 (10A)	S201-B4 (4A)	1.0	7.6
			1.5	11.4
			2.5	19.0
	S201 - Z16 (16A)	S201-B6 (6A)	1.0	5.2
			1.5	7.8
			2.5	13.0
			4.0	20.8
	S201 - Z20 (20A)	S201-B10 (10A)	1.5	12.6
			2.5	21.0
	S201 - Z25 (25A)	S201-B13 (13A)	2.5	25.0
			4.0	40.0
	RGC1P..50	<b>2 pole</b> S202 - Z25 (25A)	S202-B13 (13A)	2.5
4.0				30.4
<b>1 pole</b> S201 - Z25 (25A)		S201-B13 (13A)	2.5	7.0
			4.0	11.2
			6.0	16.8
RGC1P..42 RGC1P..62	<b>1 pole</b> S201-Z32 (32A)	S201-B16 (16A)	2.5	3.0
			4.0	4.8
			6.0	7.2
	S201-Z50 (50A)	S201-B25 (25A)	4.0	4.8
			6.0	7.2
			10.0	12.0
			16.0	19.2
	S201-Z63 (63A)	S201-B32 (32A)	6.0	7.2
			10.0	12.0
			16.0	19.2

10. Between MCB and Load (including return path which goes back to the mains).

Note: A prospective current of 6kA and a 230/400V power supply system is assumed for the above suggested specifications. For cables with different cross section than those mentioned above please consult Carlo Gavazzi's Technical Support Group.

## Accessories

### Tamper Proof Accessory Kit



### Ordering Key

Tamper proof accessory kit for RGS1P, RGC1P series containing:

- x5 transparent covers
- x5 secureness ties

**RGTMP**

Tamper proof cover & secureness tie included in packaging. Refer to instructions below for mounting to the Solid State Relay.

**RGC1P...T**

### Installation

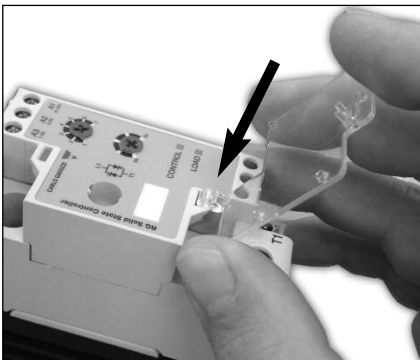

1: Clip hook of the transparent cover to the bottom loop of the RGx1P control module

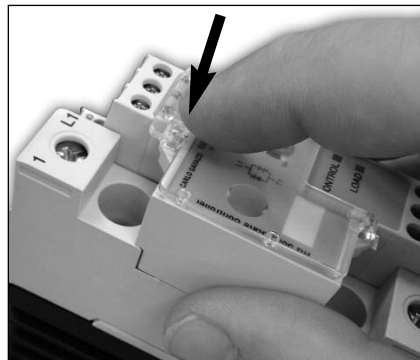

2: Close the cover by clipping to the top loop of the RGx1P control module

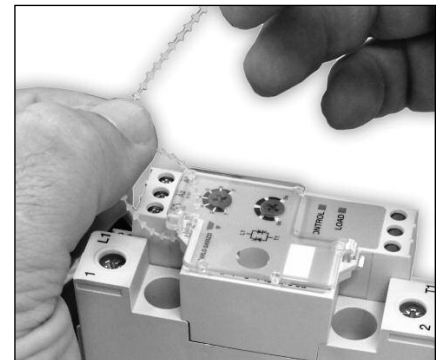

3: Secure with provided tie