

ADC7520 SERIES

1600W Battery Chargers and Power Supplies

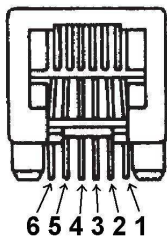

Wide output adjustment range 0...72VDC
Analog control by external 0-5VDC voltage
Temp.comp charging, sense as on option
Power fail relay alarm
Master-Slave connection



Analog control modular connector

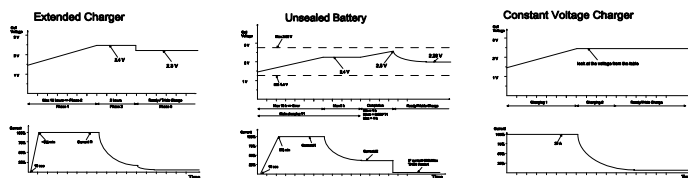

Microprocessor controlled charging curves for all kind of batteries

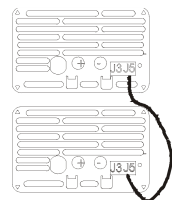

Master-Slave connection

POWER SUPPLIES AND BATTERY CHARGERS, TRIMMER ADJUSTABLE							
Type	Input voltage range **)	Nominal output voltage	Voltage setting range	Nominal output current	Current setting range	Max power	Installation / dimensions (Width x Height x Depth, mm)
ADC7520/24	55-264VAC/78-340VDC	24 VDC	0-36 VDC	60 A	0-60 A	1600W	Wall//Bench 267x135x85
ADC7520/36	55-264VAC/78-340VDC	36 VDC	0-54 VDC	40 A	0-40 A	1600W	Wall//Bench 267x135x85
ADC7520/48	55-264VAC/78-340VDC	48 VDC	0-72 VDC	30 A	0-30 A	1600W	Wall//Bench 267x135x85

ANALOG CONTROLLABLE MODELS BY EXTERNAL 0-5VDC VOLTAGE							
Type *)	Input voltage range **)	Nominal output voltage	Voltage setting range	Nominal output current	Current setting Range	Max power	Installation / dimensions (Width x Height x Depth, mm)
ADC7520/24AI	55-264VAC/78-340VDC	24 VDC	0-36 VDC	60 A	0-60 A	1600W	Wall//Bench 267x135x85
ADC7520/36AI	55-264VAC/78-340VDC	36 VDC	0-54 VDC	40 A	0-40 A	1600W	Wall//Bench 267x135x85
ADC7520/48AI	55-264VAC/78-340VDC	48 VDC	0-72 VDC	30 A	0-30 A	1600W	Wall//Bench 267x135x85

BATTERY CHARGERS WITH TEMPERATURE COMPENSATION							
Type *)	Input voltage range **)	Output voltage factory setting	Programmed output voltages (see table)	Output current (see table)	Max power	Installation / dimensions (Width x Height x Depth, mm)	
ADC7520/24T	55-264VAC/78-340VDC	27.4 VDC	5...36VDC	60 A	1600W	Wall//Bench 267x135x85	
ADC7520/36T	55-264VAC/78-340VDC	41.1 VDC	12...54VDC	40 A	1600W	Wall//Bench 267x135x85	
ADC7520/48T	55-264VAC/78-340VDC	54.8 VDC	24...72VDC	30 A	1600W	Wall//Bench 267x135x85	

*) Cable sets with modular connectors are included in packing: 1.5m cable set for analog control and 2.5m for or temp.comp models
 **) Reduced power 55...200VAC or 78...200VDC, see curves at next page

MODELS WITH POWER FAIL RELAY ALARM (24V models as a type number example)		
Type	Option description	Cable set
ADC7520/24H	Trimmer adjustable model with power fail relay alarm	1.5 m, modular connector
ADC7520/24AIH	Analog controllable model with power fail relay alarm	Analog 1.5m + relay cables 1.5m
ADC7520/24TH	Temp.comp model with Power fail relay alarm	Temp.comp 2.5m + relay cables 1.5m

MASTER-SLAVE CONNECTION (24V models as a type number example)	
Master units ***)	Slave units
ADC7520/24 or ADC7520/24AI (optional for ADC7520/24T)	ADC7520/24S RS-232 control bus in and out
Control to slave via RS-232 bus	ADC7520/24SH slave unit with relay, RS-232 bus in only

Cable set for master slave connection is included in slave unit type number, length 0.6m modular connectors in both ends

***) Master unit or slave with RS-232 bus output can not include the relay alarm

CUSTOMISED VERSIONS ON

- Cyclic battery chargers or customized charging curves for all kind of batteries
- Sense models
- Customised mechanics

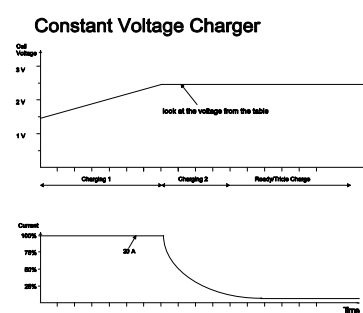
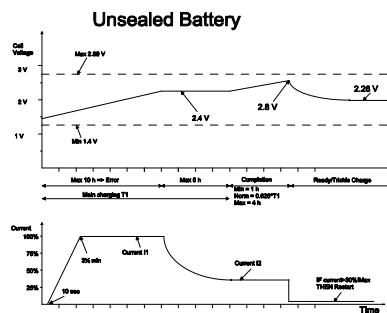
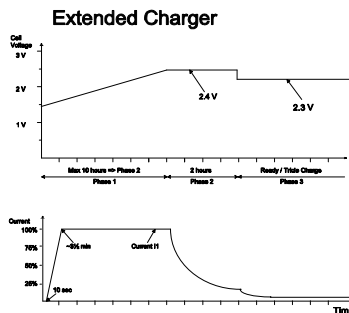

TECHNICAL DATA

Input voltage		55...264 VAC (55...200VAC reduced power, see curve below) 78...340 VDC (78...200VDC reduced power)
Input current		9 A
Power factor		>0.99
Efficiency (230VAC, 10...100% load)		> 88%
Inrush current		<30A, cold start
Line regulation		0.01%
Load regulation		0.2V
Output setting accuracy		± 0.1%
Output ripple (f > 50Hz)		<30mVrms
Hold up time		> 5ms
Status LED indication	Standard models	Orange Power OK LED
	Cyclic chargers	Three color LED, red-yellow-green
Isolations	Input - chassis	1500VAC
	Input - output	3750VAC
	Output - chassis	500VAC
Standards	Safety	EN60335-2-29 +A2
	EMC	EN55022B, EN50081-1, EN50082-2
Approvals		CE marking
Protection class	Mechanical	IP20 metal enclosure
	Electrical	Class I
Connectors	Input	Input power cord
	Output	10 mm ² 2m output cables
Dimensions	l x w x h	267 x 135 x 85 mm with rubber ends
Weight		1,9kg without output cables
Mounting		Wall, bench
Cooling		Temperature controlled fan
Operating temperature range	Full power typically	-25°C...+40°C
	Reduced power	+40...+ 70°C, see curve below
Humidity		0...95%, non condensing

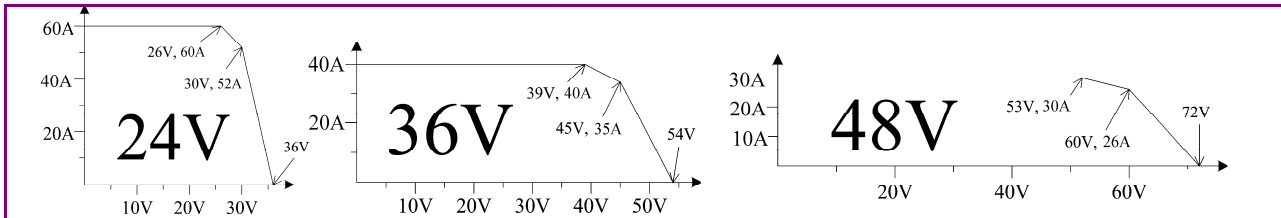

Nominal output voltage / current characteristics 1600W models

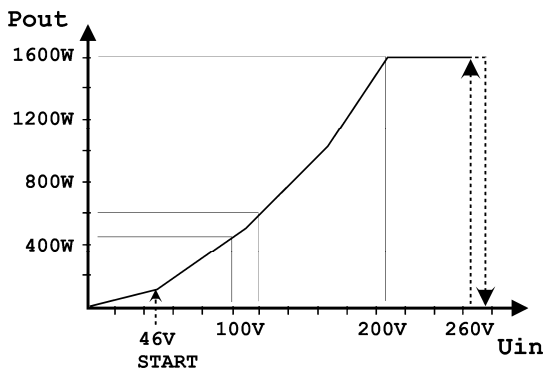

Output power / input voltage derating curve

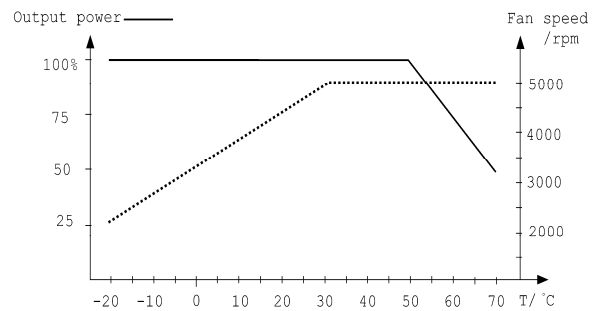

Output power and fan speed vs ambient temperature

INSTALLATION

- ← The location must be dry, dust-free indoor use. The acceptable temperature range at full power is -25°C to +40°C. A higher ambient temperature will limit the power, see diagram at first page. The power supply is not waterproof. Keep it dry and away from areas of high humidity to avoid the risk of electrical shock and damage to the charger.
- ↑ The equipment may be installed either vertically or horizontally.
- To ensure sufficient ventilation, leave approximately 10cm free space to both ends of the unit.
- ↓ The charging process generates explosive hydrogen gas. Keep the area well ventilated. Never use an open flame or equipment that produces sparks near the charger.

WALL MOUNTING

Screw the power supply to the assembly base by using the mounting brackets on the both ends of the unit.

Plug the main power cord into electrical socket. After switching on the mains switch the unit is ready to be used.

POWER SUPPLY / CHARGING OPERATION

- ← Ensure that the unit is switched off and that the environment meets the conditions described previous section
- ↑ Connect the output cables to the load / battery terminals: + cable to the + terminal and - cable to the - terminal.
- Turn the power on by turning the switch to the I position.
- ↓ During the normal power supply operation / charging process the STATUS light will show a constant orange light.
- ° To avoid sparking, turn the power off before disconnecting the cables.

CONNECTION WITH DC INPUT

Wires in PSU's power cable to be connected as follows:

L	DC input positive or negative
N	DC input negative or positive
PE	Ground

OUTPUT VOLTAGE AND CURRENT LIMIT ADJUSTMENT

Trimmer or analog control adjustable modules, type example ADC7520/24 or ADC7520/24AI:

The output voltage and output current limit of the module can be adjusted as follows:

- Trimmer adjustable models: with the multi-turn potentiometer located on the front panel
- Analog controllable models by external 0-5VDC voltage, see detailed instructions

Both voltage and current can be adjusted from zero to maximum value. Maximum 800W output power is available within the adjustment range.

Temp. comp. models, type example ADC7520/24T:

Unit includes 16pcs of programmed output voltages, see temp. comp. models setting tables page. Any of these 16 different voltage settings can be taken in use and additionally this selected voltage can be adjusted $\pm 5\%$ with the trimmer on front panel. See instructions for choosing the programmed voltage and for the fine tune trimmer adjustment.

LED

A orange LED indicates that the output of the charger module is healthy.

OUTPUT OVERCURRENT PROTECTION

Output of the unit is protected against over current and short circuits by automatic, self-resetting electronic current limit.

SERIES / PARALLEL CONNECTION

Parallel operation: No restrictions, passive load sharing.

Series operation: Up to 500V total voltage

WARNING!

Dangerous voltages, capable of causing death, are present in this equipment. Do not remove the cover. No operator serviceable parts inside. Refer servicing to qualified service personnel.

SELECTION TABLE OF ADC7520 FEATURES

<p>This table shows which features are possible at the same time.</p> <p>IF N THEN then not possible.</p> <p>Some of allowed combinations are optional. Contact manufacturer or your local distributor for further details.</p>	T r i m m e r	A n a l o g	R e l a y	B u s O u t	B u s I n	T e m p	S e n s e	C o d e S w i t c h						
	Trimmer adjustment		N			N	N	N						
	Analog control (isolated)	N				N	N	N						
	Relay alarm				N									
	BusOut (RS-232 control to slave)			N		N								
	BusIn	N	N		N									
	Temp.comp.	N	N											
	Sense													
	Customised charging algorithm chargers with code Switch	N	N											

PIN CONFIGURATION, MODULAR CONNECTORS

Front panel

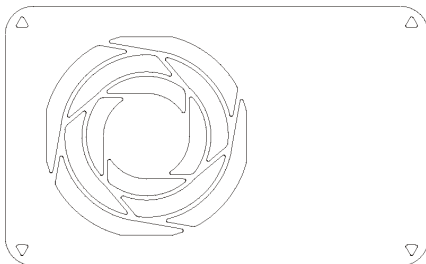

Rear panel

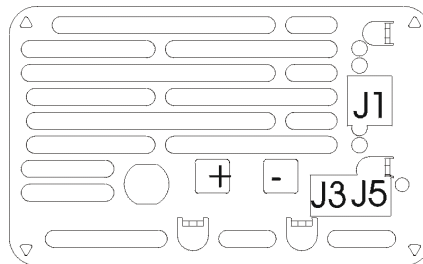

- J1: Analog input 0-5VDC
- J3: Temperature compensation, Sense option
- J5: RS-232 bus in and out, master-slave
Alternatively power fail relay alarm

OPTIONAL ALARM RELAY

If the unit is ordered with alarm relay (for example ADC7520/24H), the potential free alarm output indicates if the charger’s output is healthy. The alarm signal is activated at AC fail and charger fail cases. Both normally open and normally closed signals are presented.

Pin Configuration, Modular connector J5 with relay alarm option

MODULAR JACK

Front view

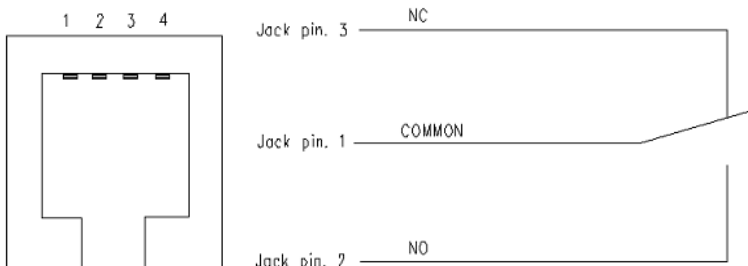

CABLE
 Black = common
 Red = NO
 Green = NC

RELAY
 Isolation:
 Output to Case: 500V
 Output to GND: 120V

Technical data:
 1A @ 24Vdc
 0,5A @ 120Vac

If power is off the COMMON is connected to NC. When power is switched ON the COMMON is connected to NO

OPTIONAL ANALOG CONTROL VERSIONS

Analog control option allows full control for output current and voltages and it gives measured values for both of these. There is also available +5V internal power source for logic use. The analog input have 500V electrical insulation to power supply's input and output.

PIN CONFIGURATION, MODULAR CONNECTOR

Interface to analog control card is made through AMP Modular 6 connector. It's part number is 215-876-1. The product specification number is 108-19064 and application number is 114-19019. Part number for cable connector that fits to modular 1 is 737 336-1.

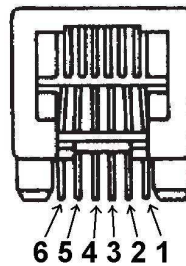
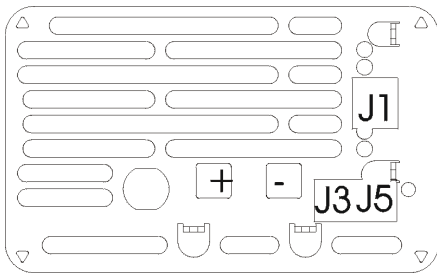

Pin configuration of J1:

1. Ground
2. Target value for current
3. Target value for voltage
4. Measured value for current
5. Measured value for voltage
6. +5V, (max 20mA) output

Controlling analog card:

All control voltages must be between 0 and 5 volts. Over 5V steering is not allowed. Logic for steering is positive so 5V in target value means maximum value from power supply and 0V means minimum output. If controlling connector is unplugged from modular connector, the power supply takes it's minimum values for output.

Measured values can be read from measured signals. Measured voltages are scaled equal as target values. If power supply lies on it's voltage reference, then measured voltage should be equal as target. Same thing on current steering and it's measured value. Measured signals (both together) can be loaded only 20mA or proper operation is not guaranteed.

Modular connector is isolated from power supply's input, enclosure and output terminals. That allows serial and parallel connection to separate power supply's so that equal steering voltages are used. Number or connected devices are not limited. Only be sure that 500V insulation voltage is not exceeded.

Connection example. using internal +5VDC power source and external potentiometers:

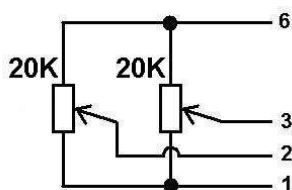

+5V output can be used to feed logic voltages for external circuits. Connection in an example works as a potentiometer controlled power supply. It is important to notice that +5V output is not allowed to load more then 20mA or proper operation is not guaranteed.

Tuning instructions:

Attention !!!

Analog interface is tuned in a factory before it is delivered to customer. There should not be any reason for tuning if card is used between 0-5V voltage values. Qualified person is needed for tuning the device. Tuning can be done with a pair of digital multi meters and example schematic above. Procedure is following:

1. Adjust from potentiometers 5V to voltage target and 2V for current target. Connect digital voltage meter to power supply output. Tune from "Voltage Set" trimmer maximum output voltage to right value.
2. Connect digital voltage meter to Modular pin number 5. Tune from trimmer "Voltage Meas" so that digital voltage meter shows always equal value as is in pin 3 (target voltage).
3. Connect digital current meter to output so that it short-circuits the output. Now tune current target potentiometer to 5V. Tune from "Current Set" trimmer output current to value that is maximum value for device according to it's specification. Be sure that your current meter has a right range. Do never exceed the current values that are specified for the device. If specified value is not known, take a contact to distributor.
4. Measure with digital multi meter voltage from Modular connector pin 4 Tune from trimmer "Current Meas" to equal with voltage in modular pin 2 (Target Current).

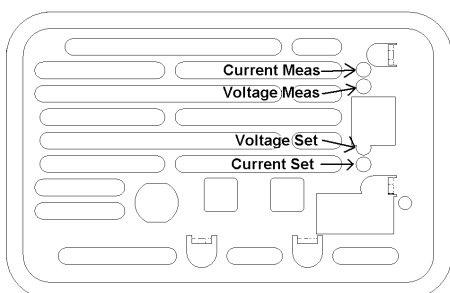

ADC7520 rear panel
Location of tuning trimmers for analog control

TEMPERATURE COMPENSATION MODELS, type number example ADC7520/24T

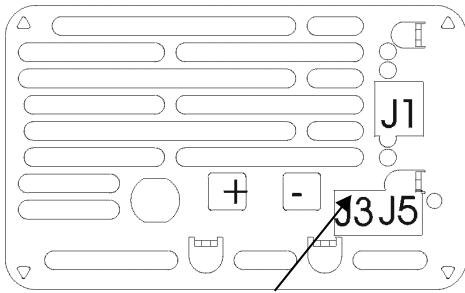

Temp.comp. / sense
Modular connector

The temp.comp cable enables the charger to adjust the output voltage in accordance with battery voltage and temperature fluctuations

See instructions for changing and adjusting the output voltage

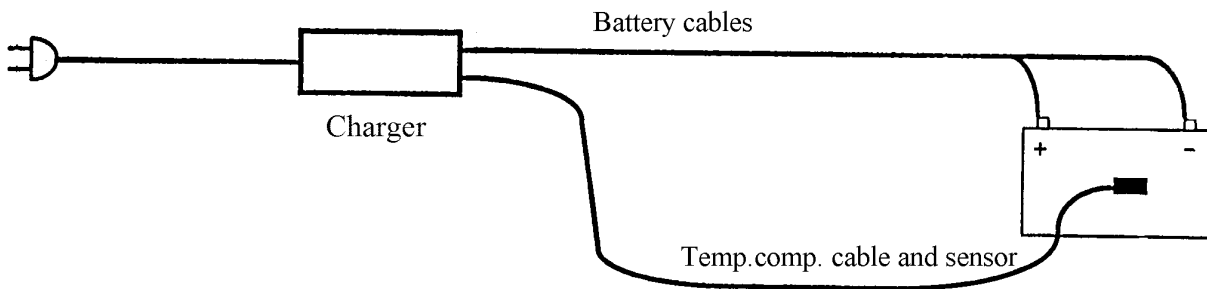

OPTIONAL MASTER SLAVE CONNECTION

Using master power supply together with Slave unit.

Master unit can be trimmer adjustable standard model ADC7520/24 or analog controllable model ADC7520/24AI (24V as an example).

Note !

Unit with relay alarm, type example ADC7520/24H can't be used as a master unit.

Slave unit is separate unit without any adjustment possibility, type ADC7520/24S or ADC7520/24SH slave with relay alarm (24V as an example).

If more current is needed adjustable Master power supply can be parallel or series connected via digital bus to Slave power supply which equals Master but is without adjustment possibility. Then output current or voltage is doubled and the both supplies can still be adjusted through multi turn potentiometers. Max one slave unit can be used in master-slave connection as a standard. (Please contact your local distributor if more slave units are needed to chain, needs special terminals/wires). Supply's output terminals and communication bus terminals are isolated so that output's series connection is allowed for more voltage.

Bus cable connection:

Master unit

Slave unit

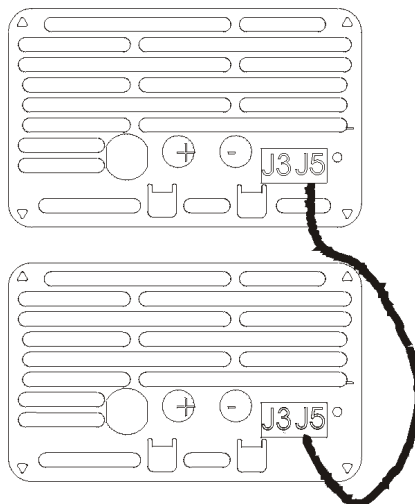

Bus cables can be connected from previous units (J5) to the next (J5) with the same way. The first unit must be the master unit (with adjusting knobs). Wrong connection does not damage the units but in that case slaves do not follow the master's commands. Quantity of the slave units is limited to max 1 pcs due to digital bus terminals. In J5 Pins 1 and 3 are serial output pins and pins 2 and 4 are serial input pins. Pin 1 is connected to pin 4 of J5 in the next unit and pin 3 to pin 2 of J5 in the next unit.

PROGRAMMED VOLTAGES FOR TEMP.COMP. MODELS, type number example ADC7520/24T

ADC7520/24T 24VDC 60A

Code switch position	Nominal Battery voltage	Voltage factory setting	Adjustment range		Output Current	Factory default
			-5%	+5%		
0		5 VDC	4,75 VDC	5,25 VDC	60 A	
1		12 VDC	11,4 VDC	12,6 VDC	60 A	
2	12 VDC	13,7 VDC	13 VDC	14,4 VDC	60 A	
3		15 VDC	14,3 VDC	15,8 VDC	60 A	
4		18 VDC	17,1 VDC	18,9 VDC	60 A	
5		20 VDC	19 VDC	21 VDC	60 A	
6		22 VDC	20,9 VDC	23,1 VDC	60 A	
7		24 VDC	22,8 VDC	25,2 VDC	60 A	
8		26 VDC	24,7 VDC	27,3 VDC	60 A	
9	24 VDC	27,4 VDC	26 VDC	28,8 VDC	60 A	X
A	24 VDC	27,4 VDC	26 VDC	28,8 VDC	40 A	
B	24 VDC	27,4 VDC	26 VDC	28,8 VDC	20 A	
C		28 VDC	26,6 VDC	29,4 VDC	maximum	
D		30 VDC	28,5 VDC	31,5 VDC	maximum	
E		33 VDC	31,4 VDC	34,7 VDC	maximum	
F		35 VDC	33,3 VDC	36 VDC	maximum	

ADC7520/36T 36VDC 40A

Code switch position	Nominal Battery voltage	Voltage factory setting	Adjustment range		Output Current	Factory default
			-5%	+5%		
0		12 VDC	11,4 VDC	12,6 VDC	40 A	
1	12 VDC	13,7 VDC	13 VDC	14,4 VDC	40 A	
2		15 VDC	14,3 VDC	15,8 VDC	40 A	
3		20 VDC	19 VDC	21 VDC	40 A	
4		24 VDC	22,8 VDC	25,2 VDC	40 A	
5	24 VDC	27,4 VDC	26 VDC	28,8 VDC	40 A	
6		30 VDC	28,5 VDC	31,5 VDC	40 A	
7		33 VDC	31,4 VDC	34,7 VDC	40 A	
8		36 VDC	34,2 VDC	37,8 VDC	40 A	
9		38 VDC	36,1 VDC	39,9 VDC	40 A	
A	36 VDC	41,1 VDC	39 VDC	43,2 VDC	maximum	X
B	36 VDC	41,1 VDC	39 VDC	43,2 VDC	30 A	
C	36 VDC	41,1 VDC	39 VDC	43,2 VDC	15 A	
D		45 VDC	42,8 VDC	47,3 VDC	maximum	
E		48 VDC	45,6 VDC	50,4 VDC	maximum	
F		52 VDC	49,4 VDC	54 VDC	maximum	

ADC7520/48T 48VDC 30A

Code switch position	Nominal Battery voltage	Voltage factory setting	Adjustment range		Output Current	Factory default
			-5%	+5%		
0		24 VDC	22,8 VDC	25,2 VDC	30 A	
1	24 VDC	27,4 VDC	26 VDC	28,8 VDC	30 A	
2		30 VDC	28,5 VDC	31,5 VDC	30 A	
3		36 VDC	34,2 VDC	37,8 VDC	30 A	
4	36 VDC	41,1 VDC	39 VDC	43,2 VDC	30 A	
5		45 VDC	42,8 VDC	47,3 VDC	30 A	
6		48 VDC	45,6 VDC	50,4 VDC	30 A	
7		52 VDC	49,4 VDC	54,6 VDC	30 A	
8	48 VDC	54,8 VDC	52,1 VDC	57,5 VDC	30 A	X
9	48 VDC	54,8 VDC	52,1 VDC	57,5 VDC	20 A	
A	48 VDC	54,8 VDC	52,1 VDC	57,5 VDC	10 A	
B		57 VDC	54,2 VDC	59,9 VDC	maximum	
C		60 VDC	57 VDC	63 VDC	maximum	
D		65 VDC	61,8 VDC	68,3 VDC	maximum	
E	60 VDC	68,5 VDC	65,1 VDC	71,9 VDC	maximum	
F		72 VDC	68,4 VDC	72 VDC	maximum	

Factory default code switch position by bold in tables

**INSTRUCTION TO CHANGE THE PROGRAMMED VOLTAGE FOR TEMP.COMP./SENSE MODELS,
type number example ADC7520/24T**

- ← Disconnect the power cord from the power line.
- ↑ Disconnect the output cables from the battery.
- See the current code switch position of the unit.
- ↓ See new switch position code from the programmed output voltages sticker on the unit
- ° Rotate the code switch to the required position.

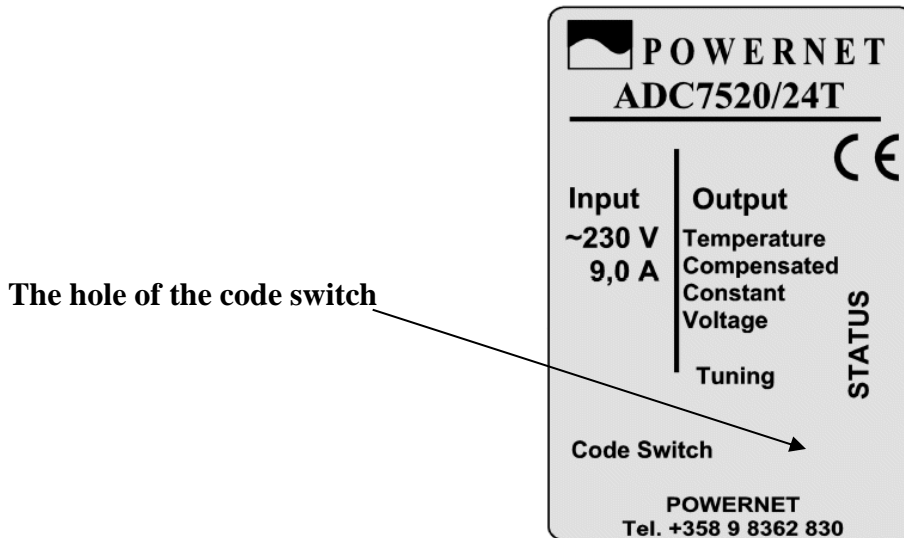

The adjustment can be checked as follows:

- Short-circuit the output cables of the charger (output short circuit).
- Connect the charger to the power line.
- Follow the Status-led color. Switch ON the charger from the on/off switch.
- Count all the number of green blinks.
- There must be as much number of blinks as the code switch position number is.

Note!

If the position of the code switch is O, Status-led blinks only once and returns to red.
The code switch positions A...F respond numbers 10...15

☺ **Now the charger has been adjusted!**

HINTS IF NOT SUCCEED

☹ You didn't have chance to count the number of blinks

=> You can start the test with the on/off switch of the charger again and count.

You have made the wrong setting

=> Switch the charger off again and make the correct setting and count the blinking to check.

☹ You cannot find the required charging algorithm on list available

=> Contact the seller / importer and ask if the charger can be updated with the algorithm you need.

**INSTRUCTION TO ADJUST TEMP.COMP/SENSE MODELS VOLTAGE BY THE TRIMMER,
type number example ADC7520/24T**

If the battery is charged in a very cold place or desired constant voltage didn't found from the charging algorithm list, then there may be need to tune the output voltage. The output voltage can be tuned +/-5% from its nominal value.

← Choose such programmed output voltage, which can reach the desired voltage by +/-5% adjustment. Read the instruction from "Changing programmed voltage".

↑ Connect the voltage meter to output wires.

→ Tune with a small screw driver the voltage calibration trimmer and check the result from volt meter. Clockwise direction increases the voltage. Look at the position below

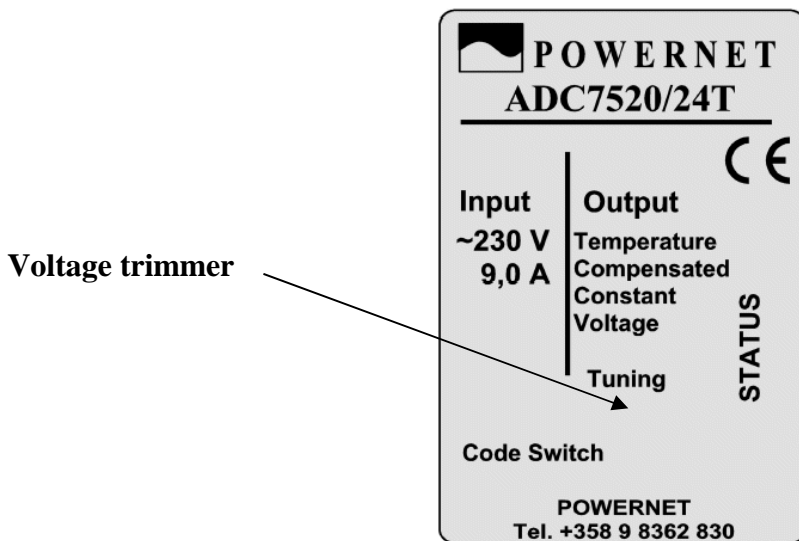

When desired voltage is found the tuning is ready.

NOTE !

The voltage tuning trimmer affects to every programmed voltage settings. The original list is not valid without returning the original tuning.

Incorrect trimmer tuning may be harmful to the battery.