

# GoTo North America Focused Delivery Program Electric Drives and Controls



# Electric Drives and Controls GoTo Catalog

Bosch Rexroth is pleased to present our Automation GoTo Product catalog as part of our GoTo Focused Delivery Program.

The GoTo Focused Delivery Program streamlines everything to make it easier for you to get a selection of our most popular Rexroth products faster. You'll benefit from quicker access to product information, reliable lead times that meet or beat the expectations of the market, and enhanced customer service.

The same GoTo product portfolio is now available in the United States, Canada, and Mexico. With the same quantities and lead times (from order acceptance to shipment in business days), GoTo is even easier to use.

For additional information on the GoTo Program and a complete list of other quality Rexroth products available in the Focused Delivery Program just go to:

**USA:** [www.boschrexroth-us.com/GoTo](http://www.boschrexroth-us.com/GoTo)

**Canada:** [www.boschrexroth.ca/GoTo](http://www.boschrexroth.ca/GoTo)

**Mexico:** [www.boschrexroth.com.mx/GoTo](http://www.boschrexroth.com.mx/GoTo)



# GoTo Focused Delivery Program

Your local GoTo contact:

## GoTo Program Delivery Conditions

- Current GoTo program content and guidelines are specified at: **[www.boschrexroth-us.com/goto](http://www.boschrexroth-us.com/goto)** or **[www.boschrexroth.ca/goto](http://www.boschrexroth.ca/goto)** or **[www.boschrexroth.com.mx/goto](http://www.boschrexroth.com.mx/goto)**
- How to Order: Please state clearly for each line item on the purchase order that GoTo lead times are required.
- Orders for products exceeding the current program quantity limits may be acknowledged with extended delivery.
- Items listed in this catalog will be shipped from a distributor or Bosch Rexroth location within the time frame stated in this catalog. For urgent delivery requirements, please check with your local sales office.

All items subject to prior sale. It is advisable to confirm critical delivery requirements at time of order. All sales subject to Bosch Rexroth Terms & Conditions of sales for your country, which you can read at:

**[www.boschrexroth-us.com](http://www.boschrexroth-us.com)** or  
**[www.boschrexroth.ca](http://www.boschrexroth.ca)** or  
**[www.boschrexroth.com.mx](http://www.boschrexroth.com.mx)**

Bosch Rexroth reserves the right to make program changes at any time without notice.

### WARNING!

Failure, improper selection or improper use of the products and/or systems described herein or of related items may cause personal injury or property damage.

This document and other information from Bosch Rexroth Corporation, Bosch Rexroth Canada Corporation, and Bosch Rexroth S.A. de C.V., including its divisions, provide products and/or system options for further investigation by users having technical expertise. It is important that you analyze all aspects of your application and review the information concerning the products or systems in Rexroth's Data Sheets. Due to the variety of operating conditions and applications for these products or systems, the user, through his own analysis and testing, is solely responsible for making the final selection of the products and systems, and assuring that all performance, safety and warning requirements are met.

The products described herein, including without limitation, product features, specifications, designs and pricing are subject to change at anytime without notice.



# Table of Contents

	Page No.
<b>Drive Systems</b>	
<b>Drives (IndraDrive Cs, C and M)</b>	<b>7</b>
<b>Motors (IndraDyn S)</b>	<b>17</b>
<b>Additional Components</b>	<b>20</b>
<b>Cables</b>	<b>22</b>
<b>Motion Control PAC</b>	
<b>IndraControl L</b>	<b>24</b>
<b>IndraControl L – Function Modules</b>	<b>25</b>
<b>IndraMotion MLC</b>	<b>27</b>
<b>IndraLogic XLC</b>	<b>28</b>
<b>Safety Control</b>	
<b>SafeLogic compact</b>	<b>29</b>
<b>CNC</b>	
<b>IndraMotion MTX micro</b>	<b>30</b>
<b>IndraMotion MTX</b>	<b>31</b>
<b>I/O</b>	
<b>Inline – Cabinet Mount (IP20)</b>	
<b>Power Modules</b>	<b>32</b>
<b>Bus Couplers</b>	<b>33</b>
<b>Block I/O</b>	<b>34</b>
<b>Digital Input Modules</b>	<b>38</b>
<b>Digital Output Modules</b>	<b>39</b>
<b>Analog Input Modules</b>	<b>41</b>

## Liability:

In no event can the manufacturer accept warranty claims or liability claims for damages resulting from improper use or misuse of the equipment or as a result of changes made to the equipment other than those authorized by the manufacturer. The manufacturer will accept no claim in which non-original spare parts have been used.

©2014, Bosch Rexroth Corporation

All rights are held by ROBERT BOSCH GMBH, BOSCH REXROTH CORPORATION, BOSCH REXROTH CANADA CORPORATION, and BOSCH REXROTH S.A. de C.V. also regarding patent claims. **We reserve the right to make technical changes at any time without notice.**

## Table of Contents (continued)

	Page No.
Analog Output Modules	42
Temperature Modules	43
Communication Modules	44
Motion and Counter Modules	45
PWM Output Module	46
IndraControl S67 – Machine Mount (IP67)	
Power Divider	48
Bus Coupler	49
Digital Input Modules (M8, M12)	50
Digital Output Modules (M8, M12)	51
Analog Input Modules (M12)	53
Analog Output Modules (M12)	55
Temperature Modules (M12)	57
Cables and Connectors	59
HMI	
Standard HMI	60
Embedded HMI	61
Software	
IndraWorks	62
VI-Composer	63
Part Numbers	65

### Liability:

In no event can the manufacturer accept warranty claims or liability claims for damages resulting from improper use or misuse of the equipment or as a result of changes made to the equipment other than those authorized by the manufacturer. The manufacturer will accept no claim in which non-original spare parts have been used.

©2013, Bosch Rexroth Corporation

All rights are held by ROBERT BOSCH GMBH, BOSCH REXROTH CORPORATION, and BOSCH REXROTH CANADA CORPORATION, also regarding patent claims. **We reserve the right to make technical changes at any time without notice.** Errors and omissions excepted.

GoTo Focused Delivery Program: Drive Systems

# Drives – IndraDrive Cs

	<p>The IndraDrive Cs is a servo drive that features a compact space-saving design. Selectable Multi-Protocol Ethernet command interface provides the flexibility of choosing any open Ethernet controller for the system, SERCOS III for example. A Multi-encoder interface allows use of the platform with virtually any motor technology, for instance torque or linear motor technologies.</p>
<p>For complete engineering and design information:  <b>GoTo <a href="http://www.boschrexroth-us.com/GoToDriveSystems">www.boschrexroth-us.com/GoToDriveSystems</a></b></p>	

## Features

- Ethernet-based communications, multi-protocol support: SERCOS III, Profi Net IO, EtherNet/IP and EtherCat
- Innovative multi-encoder interface: Hiperface®, EnDat 2.1, 1Vss, 5 V TTL, and Rexroth MSM and MSK servo motors
- Energy efficient product – DC bus sharing
- Standard , Servo and Synchronization modes available
- Digital inputs/outputs and analog input on board
- Intelligent operating panel with programming module function, supports device swap without a PC
- IEC-compliant motion logic IndraMotion MLD (optional)
- Integrated Safe Torque Off or Safe Motion safety technology up to category 4 PLe according to ISO13849-1 and SIL 3 according to IEC 62061 (optional)
- Integrated brake resistor; external brake resistor can be connected as an alternative

## Technical Data

Models	HCS01.1E-W0006-A-02	HCS01.1E-W0013-A-02	HCS01.1E-W0008-A-03	HCS01.1E-W0018-A-03	HCS01.1E-W0028-A-03	HCS01.1E-W0054-A-03	
<b>Performance Data</b>							
Mains voltage	V	1/3 AC 110...230 V		3 AC 200 ... 500 V			
Continuous current	$A_{eff}$	2.34	4.4	2.7	7.6	11.5	21
Maximum current	$A_{eff}$	6	13	8	18	28	54
Maximum output without/with choke	kW	0.25 / –	0.8 / –	0.86 / –	1.7/ –	2.6/4.0	9.0 / 14.0
<b>Mechanical data</b>							
Width W	mm	50		70		130	
Height H (max)	mm	215		268		268	
Depth D (max)	mm	220		220		220	
Mass	kg	0.72		1.7		4.22	

Available Firmware Options	
FWA-INDRV*-MPB-16VRS-D5-1-ALL-NN	Basic closed loop 16VRS with the possibility to select synchronization, servo or main spindle extension set
FWA-INDRV*-MPB-17VRS-D5-1-NNN-NN	Basic closed loop 17VRS without the possibility to select synchronization, servo or spindle extension set
FWA-INDRV*-MPB-17VRS-D5-1-SNC-NN	Basic closed loop 17VRS with synchronization only extension set
FWA-INDRV*-MPB-17VRS-D5-1-ALL-NN	Basic closed loop 17VRS with the possibility to select synchronization, servo or spindle extension set
FWA-INDRV*-MPB-17VRS-D5-1-ALL-ML	Basic closed loop 17VRS with the possibility to select synchronization, servo or spindle extension set and MLD master

See index Page 65 for GoTo product and accessory part numbers.

GoTo Focused Delivery Program: Drive Systems

# Drives – IndraDrive C

## Power Sections



IndraDrive sets new standards in drive technology with a combination of three product advantages: scalability in power and functionality, consistency in technology, engineering and operation and openness in communication. The IndraDrive C series of converters integrate inverter and power supply in one unit. The compact construction contains additional mains connection components, making it particularly suitable for single and multi axis applications.

For complete engineering and design information:  
**GoTo [www.boschrexroth-us.com/GoToDriveSystems](http://www.boschrexroth-us.com/GoToDriveSystems)**

### Features

- Ethernet-based communications, multi-protocol support: SERCOS III, Profi Net IO, EtherNet/IP and EtherCat
- Compact converters and modular inverters on one platform
- Integrated motion logic with IEC-compliant PLC
- Drive-integrated safety technology
- Energy efficient product - DC bus sharing
- Standard , Servo and Synchronization modes available
- Complete range of scalable drives
- Digital inputs/outputs and analog input on board
- Intelligent operating panel with programming function supports device swap without a PC
- Integrated brake resistor, alternative an external brake resistor can be connected

### Technical Data

Models		HCS02.1E-W0012	HCS02.1E-W0028	HCS02.1E-W0054	HCS02.1E-W0070
<b>Performance data</b>					
Mains voltage	V	3 AC 200 ... 500 V			
Continuous current	A <sub>eff</sub>	4.5	11.3	20.6	28.3
Maximum current	A <sub>eff</sub>	11.5	28.3	54	70.8
Maximum output without/with choke	kW	5/5	8/10	12/16	14/19
<b>Mechanical data</b>					
Width W	mm	65	65	105	105
Height H (max)	mm	290	352		
Depth D (max)	mm	252			
Mass	kg	2.9	3.8	6.7	6.8

*continued on next page*

See index Page 65 for GoTo product and accessory part numbers.



GoTo Focused Delivery Program: Drive Systems

# Drives – IndraDrive C (continued)

## Power Sections

### Technical Data (continued)

Models		HCS03.1E-W0070-A-05-NNBV	HCS03.1E-W0100-A-05-NNBV	HCS03.1E-W0150-A-05-NNBV
<b>Performance data</b>				
Continuous current	A	45	73	95
Maximum current	A	70	100	150
DC bus continuous power without/with choke	kW	13/25	24/42	34/56
Maximum output without/with choke	kW	20/40	33/59	54/89
Mains voltage	V	3 AC 400 to 500 (+10%/–15%)		
Continuous input mains current	A	50	80	106
Dependence of output on mains voltage		at $U_{LN} < 400$ V: 1% power reduction per 4 V decrease in voltage		
DC bus terminal		•	•	•
DC bus capacity	µF	940	1,440	1,880
<b>Brake chopper</b>				
Permanent braking power	kW	13.2	18.9	25.2
Maximum braking power	kW	42	63	97
<b>Control voltage data</b>				
Control voltage, internal	V	DC 24 (not for supply of motor holding brake)		
Control voltage, external	V	DC 24 ±20% (DC 24 ±5% when supplying motor holding brake)		
Power consumption without control unit & motor brake	W	22.5	25	25
Continuous current without control unit & motor brake	A	0.9	1	1
<b>Mechanical data</b>				
Width W	mm	125	225	225
Height H (max)	mm	440		
Depth D (max)	mm	315		
Mass	kg	13	20	20

See index Page 65 for GoTo product and accessory part numbers.

GoTo Focused Delivery Program: Drive Systems

# Drives – IndraDrive M

## Inverters – single axis



Multi-axis solution with power supplies and inverters.

Multi-axis applications are the domain of the modular system IndraDrive M. Power supplies provide the necessary DC bus voltage for the inverters. Compact single-axis or double-axis inverters and power supplies with integrated mains connection components enable compact solutions for large axis groups.

For complete engineering and design information:  
**GoTo [www.boschrexroth-us.com/GoToDriveSystems](http://www.boschrexroth-us.com/GoToDriveSystems)**

### Features

- Single-axis inverter with maximum current from 20 A to 350 A
- Space-saving design for multi-axis applications
- Can be powered via power supply unit or converter
- Energy exchange via common DC bus
- Can be connected to a converter for cost-effective solutions

### Technical Data

Models		HMS01.1N- W0020-A-07- NNNN	HMS01.1N- W0036-A-07- NNNN	HMS01.1N- W0054-A-07- NNNN	HMS01.1N- W0070-A-07- NNNN	HMS01.1N- W0110- A-07- NNNN	HMS01.1N- W0150-A-07- NNNN	HMS01.1N- W0210- A-07- NNNN
<b>Performance data</b>								
Continuous current	A	12.1	21.3	35	42.4	68.5	100	150
Maximum current	A	20	36	54	70	110	150	210
<b>Control voltage data</b>								
Control voltage, external	V	DC 24 ±20% (DC 24 ±5% when supplying motor holding brake)						
Power consumption without control unit and motor brake	W	10	15	10	16	34	23	75
Continuous current without control unit and motor brake	A	0.4	0.7	0.4	0.7	1.4	1.0	3.1
<b>Mechanical data</b>								
Width W	mm	50	50	75	100	125	150	200
Height H (max)	mm	440						
Depth D (max)	mm	309						
Weight	kg	5.3	5.3	6.7	7.9	11	12.7	16.4

See index Page 65 for GoTo product and accessory part numbers.

GoTo Focused Delivery Program: Drive Systems

# Drives – IndraDrive M

## Inverters – double axis

### Technical Data

Models		HMD01.1N-W0012-A-07-NNNN	HMD01.1N-W0020-A-07-NNNN	HMD01.1N-W0036-A-07-NNNN
<b>Performance data</b>				
Continuous current	A	7	10	20
Maximum current	A	12	20	36
<b>Control voltage data</b>				
Control voltage, external	V	DC 24 ±20% (DC 24 ±5% when supplying motor holding brake)		
Power consumption without control unit and motor brake	W	17	17	11
Continuous current without control unit and motor brake	A	0.7	0.7	0.5
<b>Mechanical data</b>				
Width W	mm	50	50	75
Height H (max)	mm	440		
Depth D (max)	mm	309		
Weight	kg	5.5	5.7	7.5

See index Page 65 for GoTo product and accessory part numbers.

GoTo Focused Delivery Program: Drive Systems

# Drives – IndraDrive M

## Power Supply

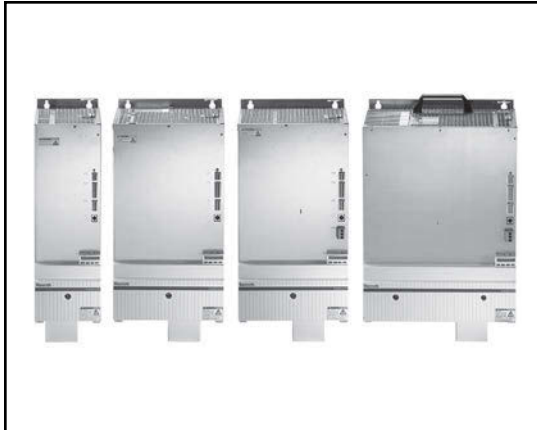

Maximum energy efficiency can be achieved with power supplies that are capable of mains regeneration. Beside the power recovery encountered in regenerative operation of the drives, these devices also feature sinusoidal line currents, an overall power factor of 0.99 and a closed-loop DC bus.

For complete engineering and design information:  
**GoTo [www.boschrexroth-us.com/GoToDriveSystems](http://www.boschrexroth-us.com/GoToDriveSystems)**

### Features

- Power range from 15 kW to 120 kW
- Direct mains connection from 400 V to 480 V
- Energy-saving line regeneration
- Integrated mains contactor
- Integrated brake resistor

### Technical Data

Models		HMV01.1E-W0030-A-07-NNNN	HMV01.1E-W0075-A-07-NNNN	HMV01.1R-W0018-A-07-NNNN	HMV01.1R-W0045-A-07-NNNN	HMV01.1R-W0065-A-07-NNNN
<b>Performance data</b>						
DC bus continuous power without/with choke	kW	18/30	45/75	-/18	-/45	-/65
Maximum output	kW	45	112	45	112	162
Mains voltage	V	3 AC 400 to 480 (+10%/–15%)				
Continuous input mains current	A	51	125	26	65	94
Dependence of output on mains voltage		at $U_{LN} < 400$ V: 1% power reduction per 4 V				
		at $U_{LN} > 400$ V: 1% power gain per 4 V		at $U_{LN} > 400$ V: no power gain		
DC bus capacity	µF	1,410	3,760	705	1,880	2,820
DC bus voltage range	V	DC 435 to 710		DC 750 (regulated)		
<b>Brake resistor</b>						
Brake resistor		Internal				
Maximum braking energy consumption	kWs	100	250	80	100	150
Permanent braking power	kW	1.5	2	0.4	0.4	0.4
Maximum braking power	kW	36	90	36	90	130

*continued on next page*

See index Page 66 for GoTo product and accessory part numbers.

GoTo Focused Delivery Program: Drive Systems

# Drives – IndraDrive M (continued)

## Power Supply

### Technical Data (continued)

Models		HMV01.1E-W0030-A-07-NNNN	HMV01.1E-W0075-A-07-NNNN	HMV01.1R-W0018-A-07-NNNN	HMV01.1R-W0045-A-07-NNNN	HMV01.1R-W0065-A-07-NNNN
<b>Control voltage data</b>						
Control voltage, internal	V	DC 24 ±5%				
Power consumption	W	25	30	31	41	108
Continuous current	A	1	1.3	1.3	1.9	4.5
<b>Mechanical data</b>						
Width W	mm	150	250	175	250	350
Height H (max)	mm	440				
Depth D (max)	mm	309				
Weight	kg	13.5	22	13.5	20	31

See index Page 66 for GoTo product and accessory part numbers.

GoTo Focused Delivery Program: Drive Systems

# Drives – IndraDrive C and M

## Control Sections

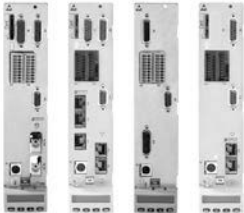

We can supply control units tailored to your specific application, ranging from standard to high-end applications. Integrated motion logic, numerous technology functions, certified safety technology and standardized interfaces leave nothing to be desired.

The correct interface for connecting the IndraDyn motors or other standardized encoders, such as Hiperface®, is already integrated.

For complete engineering and design information:  
**GoTo [www.boschrexroth-us.com/GoToDriveSystems](http://www.boschrexroth-us.com/GoToDriveSystems)**

### Features

- ADVANCED control units meet the highest demands in performance and dynamics.
- Signal transfer via fiber optics guarantees the secure exchange of real-time data with minimal wiring.
- Conventional ±10 V analog interface
- Digital inputs/outputs and analog input on board
- Standard , Servo and Synchronization modes available
- Intelligent operating panel with programming function supports device swap without a PC
- Scalable performance and functionality
- An additional plug-in MultiMediaCard gives you the option of simple transmission or duplication of your drive parameters.
- A standard encoder interface for IndraDyn motors is already featured among the BASIC control units.
- Integrated motion logic with IEC-compliant PLC
- Drive-integrated safety technology

### Available Hardware Options

Overview	Basic Open Loop	Basic Analog	Basic PROFIBUS	Basic Sercos	Basic Universal	Double-axis Basic Universal <sup>6)</sup>	Advanced
<b>Control communication</b>							
Analog/digital for Open Loop operation	●	–	–	–	–	–	–
Analog interface	–	●	–	–	–	–	○ <sup>1)</sup>
Parallel interface	–	–	–	–	○	–	○
PROFIBUS	–	–	●	–	○	–	○
sercos II	–	–	–	●	○	–	○
sercos III	–	–	–	–	○	–	○
Multi-Ethernet	–	–	–	–	○	–	○
CANopen	–	–	–	–	○	–	○
DeviceNet	–	–	–	–	○	–	○

● Standard      1) In conjunction with additional options      3) Only with sercos III and EtherCAT      5) Supply voltage 5 V  
 ○ Optional      2) Encoder interface for IndraDyn motors      4) Supply voltage 12 V      6) Only in connection with power unit HMD

*continued on next page*

See index Page 66 for GoTo product and accessory part numbers.

GoTo Focused Delivery Program: Drive Systems

# Drives – IndraDrive C and M (continued)

## Control Sections

### Available Hardware Options (continued)

Overview	Basic Open Loop	Basic Analog	Basic PROFIBUS	Basic Sercos	Basic Universal	Double-axis Basic Universal <sup>6)</sup>	Advanced	
<b>Configurations</b>								
Option 1	–	● <sup>2)</sup>	● <sup>2)</sup>	● <sup>2)</sup>	● <sup>2)</sup>	●/●	●	
Option 2	–	–	–	–	●	●/●	●	
Option 3	–	–	–	–	–	–	●	
Safety option	–	●	●	●	●	●/●	●	
Slot for MultiMediaCard	–	–	–	–	●	●	●	
<b>Encoder interfaces</b>								
IndraDyn motors MSK, MKE, MAD and MAF, Hiperface®, 1 V <sub>pp</sub> and 5 V TTL <sup>4)</sup>	–	●	●	●	●	○	○	
MHD and MKD motors	–	–	–	–	○	○	○	
EnDat 2.1, 1 V <sub>pp</sub> and 5 V TTL <sup>5)</sup>	–	–	–	–	○	○	○	
<b>Safety options compliant with EN 13849-1 and EN 62061</b>								
Safe Torque Off (category 3 PL e/SIL <sup>3)</sup>	–	○	○	○	○	○	○	
Safe Motion (category 3 PL d/SIL <sup>2)</sup>	–	–	–	–	–	○	○	
<b>Extensions</b>								
Encoder emulation	–	●	–	–	○	○	○	
Analog I/O extension	–	–	–	–	○	○	○	
Digital I/O extension	–	–	–	–	–	–	○	
Digital I/O with SSI interface	–	–	–	–	–	–	○	
Cross communication	–	–	–	–	–	–	○	
<b>Software module</b>								
MultiMediaCard	–	–	–	–	○	○	○	
<b>Operator panel</b>								
Standard	●	●	●	●	●	●	●	
<b>Cycle times</b>								
Current control	[μs]	125					62.5	
Speed control	[μs]	250					125	
Position control	[μs]	500					250	
<b>PWM frequency</b>								
4/8 kHz	●/●	●/●	●/●	●/●	●/●	●/●	●/●	
12/16 kHz	–/–	–/–	–/–	–/–	–/–	–/–	●/●	
<b>Inputs/outputs</b>								
Digital inputs/of which utilizable for probes	8/–	5/–	5/1	5/1	5/1	18/2	7/2	
Digital inputs/outputs (user-defined settings)	–	4	3	3	3	4	4	
Analog inputs	2	2	–	–	–	1	1	
Analog outputs	2	–	–	–	–	2	2	
Relay outputs	3	1	1	1	1	1	1	
<b>Interfaces</b>								
RS232	●	●	●	●	●	●	●	
<b>Control voltage data</b>								
Control voltage	[V]	DC 24						
Power consumption without options	[W]	7.5	8	7.5	7.5	6.5	7.5	6
Continuous current without options	[A]	0.31	0.33	0.31	0.31	0.27	0.31	0.25

● Standard      1) In conjunction with additional options      3) Only with sercos III and EtherCAT      5) Supply voltage 5 V  
 ○ Optional      2) Encoder interface for IndraDyn motors      4) Supply voltage 12 V      6) Only in connection with power unit HMD

See index Page 66 for GoTo product and accessory part numbers.

GoTo Focused Delivery Program: Drive Systems

## Drives – IndraDrive C and M (continued)

### Control Sections

#### Available Firmware Options

FWA-INDRV*-MPB-05VRS-D5-1-NNN-NN	Basic single-axis closed loop 05VRS without the possibility to select synchronization, servo or main spindle extension set
FWA-INDRV*-MPB-05VRS-D5-1-SNC-NN	Basic single-axis closed loop 05VRS with synchronization only extension set
FWA-INDRV*-MPB-07VRS-D5-0-NNN-NN	Basic single-axis open loop 07VRS
FWA-INDRV*-MPB-07VRS-D5-1-NNN-NN	Basic single-axis closed loop 07VRS without the possibility to select synchronization, servo or main spindle extension set
FWA-INDRV*-MPB-07VRS-D5-1-SNC-NN	Basic single-axis closed loop 07VRS with synchronization extension set
FWA-INDRV*-MPH-07VRS-D5-1-NNN-NN	Advanced single-axis closed loop 07VRS without the possibility to select synchronization, servo or main spindle extension set
FWA-INDRV*-MPH-08VRS-D5-1-NNN-NN	Advanced single-axis closed loop 08VRS without the possibility to select synchronization, servo or main spindle extension set
FWA-INDRV*-MPH-07VRS-D5-1-SNC-NN	Advanced single-axis closed loop 07VRS with synchronization extension set
FWA-INDRV*-MPC-07VRS-D5-1-NNN-ML	Advanced single-axis closed loop 07VRS for MLD master (software module PFM...-FW reqd.) FW
FWA-INDRV*-MPC-07VRS-D5-1-SNC-ML	Advanced single-axis closed loop 07VRS with synchronization extension set for MLD master (software module PFM...-FW reqd.)
FWA-INDRV*-MPC-08VRS-D5-1-NNN-ML	Advanced single-axis closed loop 08VRS for MLD master (software module PFM...-FW reqd.) FW
FWA-INDRV*-MPC-07VRS-D5-1-ALL-MA	Advanced single-axis closed loop 07VRS with all extension sets for MLD master (software module PFM...-FW required)
FWA-INDRV*-MPD-07VRS-D5-1-NNN-NN	BASIC double-axis closed loop 07VRS without the possibility to select synchronization, servo or main spindle extension set
FWA-INDRV*-MPD-07VRS-D5-1-SNC-NN	BASIC double-axis closed loop 07VRS with synchronization extension set

#### Software module

MultiMediaCard - PFM02.1-016-FW	Optional with Basic Universal and Advanced control sections
	Required for control sections and MPC-firmware with MLD master

See index Page 66 and 67 for GoTo product and accessory part numbers.



GoTo Focused Delivery Program: Drive Systems

# Motors – IndraDyn S

## MSK Motor



The particularly outstanding features of the MSK range of motors are its wide power spectrum and narrow size increments. The high torque density of these synchronous servo motors allows a particularly compact design with maximum torques of up to 495 Nm.

A number of further options, such as the shaft keyway, holding brake, reduced runout and the high protection category IP65 mean that they can be used in virtually any application.

For complete engineering and design information:  
**GoTo [www.boschrexroth-us.com/GoToDriveSystems](http://www.boschrexroth-us.com/GoToDriveSystems)**

### Features

- Motors with the highest level of efficiency
- High protection category IP65
- Multi-turn encoder (Hiperface®) – 128 increments with 4,096
- Encoder systems for a wide and diverse range of applications
- Digital type plate and parameter memory

### Performance Data

Type	Maximum speed nMax (1/min)	Continuous torque at standstill M0 (Nm)	Maximum torque MMax (Nm)	Continuous current at standstill I0 (A)	Maximum current IMax (A)	Moment of inertia J (kgm2)
MSK030C-0900	9,000	0.4	1.8	1.5	6.8	0.000013
MSK040B-0600	7,500	1.7	5.1	2	8	0.0001
MSK040C-0450	6,000	2.7	8.1	2.4	9.6	0.00014
MSK040C-0600	7,500			3.1	12.4	
MSK050C-0600	6,000	5	15	6.2	24.8	0.00033
MSK060C-0300	4,900	8	24	4.8	19.2	0.0008
MSK061C-0600	6,000		32	7.7	34.7	0.000752
MSK071E-0300	4,200	23	84	12.5	56.3	0.0029
MSK071E-0450	6,000			20	90.1	
MSK076C-0300	4,700	12	43.5	7.2	32.4	0.0043
MSK100B-0300	4,500	28	102	17.4	78.3	0.0192
MSK100C-0300	4,500	38	148	21.6	97.2	0.0273
MSK101D-0450	6,000	50	160	41.7	187.7	0.00932

*continued on next page*

See index Page 67 for GoTo product and accessory part numbers.

GoTo Focused Delivery Program: Drive Systems

## Motors – IndraDyn S (continued)

## MSK Motor

## Dimensional Data

Type	A (mm)	B (mm)	C (mm)	Ø D (mm)	Ø E (mm)	Ø F (mm)	Ø G (mm)	H (mm)	Weight (kg)
MSK030C-0900	54	152.5	20	9	40	63	4.5	98.5	1.3
MSK040B-0600	82	155.5	30	14	50	95	6.6	124.5	2.8
MSK040C-0450	82	185.5	30	14	50	95	6.6	124.5	3.6
MSK040C-0600									
MSK050C-0600	98	203	40	19	95	115	9	134.5	5.4
MSK060C-0300	116	226	50	24	95	130	9	156	8.4
MSK061C-0600	116	264	40	19	95	130	9	156	8.3
MSK071E-0300	140	352	58	32	130	165	11	202	23.5
MSK071E-0450									
MSK076C-0300	140	292.5	50	24	110	165	11	180	13.8
MSK100B-0300	192	368	60	32	130	215	14	211.5	34
MSK100C-0300	192	434	60	32	130	215	14	211.5	45.1
MSK101D-0450	192	410	80	38	180	215	14	262	40

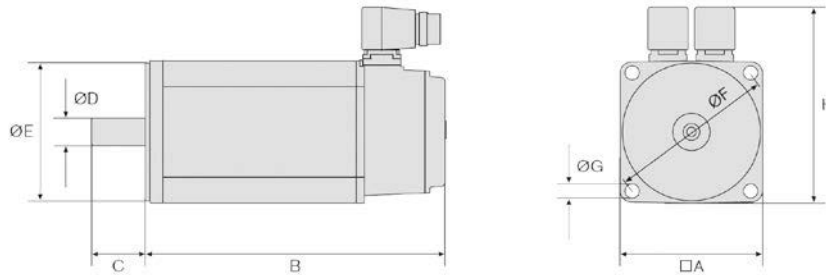

See index Page 67 for GoTo product and accessory part numbers.

GoTo Focused Delivery Program: Drive Systems

# Motors – IndraDyn S

## MSM Motor



Maintenance-free MSM motors are available in five sizes rated at up to 750 W continuous mechanical power. These short-length motors feature high power density and minimized flange dimensions, making them the ideal choice in a wide range of application scenarios.

The IP54 motors come with an absolute encoder and optional holding brake, and they can easily be connected to IndraDrive Cs power units with a 1/3 AC 110...230 V line input.

For complete engineering and design information:  
**GoTo [www.boschrexroth-us.com/GoToDriveSystems](http://www.boschrexroth-us.com/GoToDriveSystems)**

### Features

- Torque up to 7.1 Nm
- Speed up to 5,000 rpm
- Multi-turn absolute encoder
- High dynamic performance
- High performance density

### Performance Data

Type	Rated power	Continuous torque at standstill	Maximum torque	Maximum speed	Moment of inertia
	PN (W)	M0 (Nm)	MMax (Nm)	nMax (1/min)	J (kgm <sup>2</sup> )
MSM019B	100	0.32	0.95	5,000	0.0000025
MSM031B	200	0.64	1.91	5,000	0.0000051
MSM031C	400	1.3	3.8	5,000	0.000014
MSM041B	750	2.4	7.1	4,500	0.000087

### Dimensional Data

Type	A (mm)	B (mm) <sup>1)</sup>	C (mm)	Ø D (mm)	Ø E (mm)	Ø F (mm)	Ø G (mm)	H (mm)	Weight (kg) <sup>1)</sup>
MSM019B	38	92 / 122	25	8	30	45	3.4	51	0.47 / 0.68
MSM031B	60	79 / 115.5	30	11	50	70	4.5	73	0.82 / 1.3
MSM031C	60	98.5 / 135	30	14	50	70	4.5	73	1.2 / 1.7
MSM041B	80	112 / 149	35	19	70	90	6	93	2.3 / 3.1

1) dimensions with / without brake.

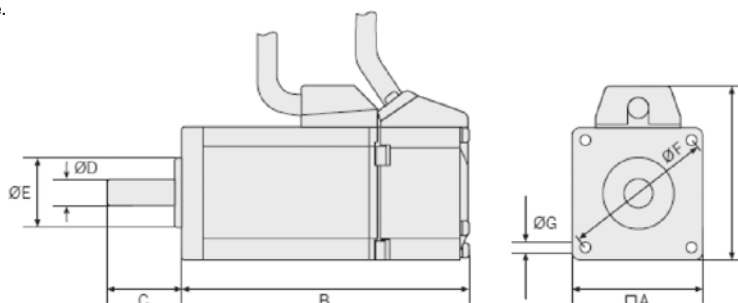

See index Page 68 for GoTo product and accessory part numbers.

GoTo Focused Delivery Program: Drive Systems

## Additional Components



Additional components ensure that the EMC limit values are adhered to and suppress leakage current generated by line capacitors. Our mains filters, braking resistors and capacitor modules are optimally coordinated with the power units and are scalable in regards to current, number of drives and motor cable length depending on your application needs. They can be combined with our shielded motor cables for trouble-free operation conforming to EN 61800-3, Class A, Group 2, even with single cable lengths of up to 75 m.

For complete engineering and design information:  
**GoTo [www.boschrexroth-us.com/GoToDriveSystems](http://www.boschrexroth-us.com/GoToDriveSystems)**

### Technical Data

Main filters for HCS converters						
Type	Continuous current	Power dissipation	Width	Height	Depth	Mass
	A	W	mm	mm	mm	kg
NFD03.1-480-007	7	3.9	50	160	90	0.7
NFD03.1-480-016	16	6.4	55	220	90	1
NFD03.1-480-030	30	11.9	60	270	100	1.4
NFD03.1-480-055	55	25.9	90	220	105	2
NFD03.1-480-075	75	30.4	90	240	145	3.5
NFD03.1-480-130	130	38	100	240	160	4.7

Braking resistors	Max. energy consumption	Braking power				Width	Height	Depth	Mass
		Duration	Max.	t <sub>on</sub> time	t <sub>cycle</sub> time				
	kWs	kW	kW	s	s	mm	mm	mm	kg
HLB01.1C-01K0-N06R0-A-007-NNNN	100	1	100	1	100	65	352	252	5.8
HLB01.1D-02K0-N03R4-A-007-NNNN	500	2	180	2.7	250	100	440	309	12.2

Capacity modules	Capacitance	Width	Height	Depth	Weight
	mF	mm	mm	mm	kg
HLC01.1C-02M4-A-007-NNNN	2.4	50	352	251.5	4.3
HLC01.1D-05M0-A-007-NNNN	5	75	440	309	8.6

*continued on next page*

See index Page 68 for GoTo product and accessory part numbers.

## Additional Components (continued)

### Accessories

<b>Basic accessories HAS01</b> – The basic accessories contain all the mounting parts and fixing elements for installing the devices referenced in the table below (not needed for HCS01.1).	
Type	needed with
HAS01.1-065-NNN-CN	HCS02.1...W0012/W0028
HAS01.1-065-072-CN	HCS02.1...W0028
HAS01.1-105-NNN-CN	HCS02.1...W0054/W0070
HAS01.1-105-072-CN	HCS02.1...W0054/W0070
HAS01.1-125-072-CN	HCS03.1...W0070
HAS01.1-225-072-CN	HCS03.1...W0100/W0150
HAS01.1-050-072-MN	HMS01.1...W0020/W0036, HMD01.1...W0012/W0020
HAS01.1-075-072-MN	HMS01.1...W0054, HMD01.1...W0036
HAS01.1-100-072-MN	HMS01.1...W0070
HAS01.1-150-072-MN	HMS01.1...W0150, HMV01.1E-W0030
HAS01.1-175-072-MN	HMV01.1R-W0018
HAS01.1-200-072-MN	HMS01.1...W0210
HAS01.1-250-072-MN	HMV01.1E-W0075, HMV01.1R-W0045
HAS01.1-350-072-MN	HMV01.1R-W0065

<b>Shield connection HAS02</b> – The shield connection plate is an EMC-compatible method of connecting the motor power cable to the devices referenced in the table below. It also serves as a cord grip (not needed for HCS01.1).	
Type	needed with
HAS02.1-001-NNN-NN	HMS01.1...W0020-W0070
HAS02.1-002-NNN-NN	HCS02.1...W0012-W0070, HMD01.1...W0012-W0036
HAS02.1-003-NNN-NN	HMS01.1...W0110-W0210
HAS02.1-004-NNN-NN	HCS03.1...W0070
HAS02.1-005-NNN-NN	HCS03.1...W0100/W0150

<b>Connection Points HAS05</b> – Universal adapter for safety technology for easier X41 wiring of 2nd channel	
Type	optional (for control sections with L2/S2 safety - X41 adapter )
HAS05.1-007-NNL-NN	Adapter from D-Sub to terminal connector – fitting direction: left-hand
HAS05.1-007-NNR-NN	Adapter from D-Sub to terminal connector – fitting direction: right-hand

See index Page 68 for GoTo product and accessory part numbers.

GoTo Focused Delivery Program: Drive Systems

# Cables

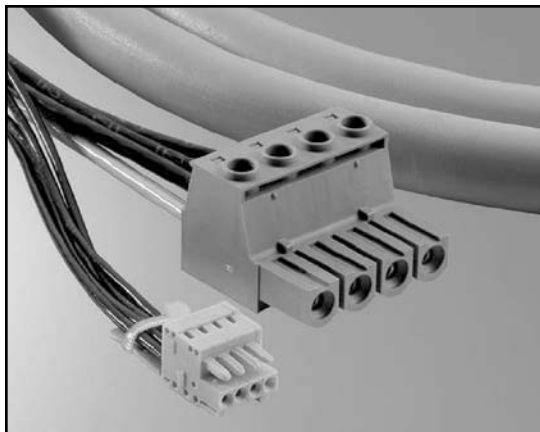

Motor Power- and Feedback Cable assemblies for IndraDrive C, M, and Cs drives with IndraDyn S motors in the GoTo program are offered in multiple lengths and are completely assembled with connectors for easy installation.

Interface/Communication cables for connection of control units and system peripherals or start-up/commissioning via PC as described by type.

For complete engineering and design information:  
**GoTo [www.boschrexroth-us.com/GoToDriveSystems](http://www.boschrexroth-us.com/GoToDriveSystems)**

## Technical Data

Motor power cable	Length <sup>1)</sup>		Connecting	
			Drives	Motors
RKL0013/005.0	fixed	5m	IndraDrive Cs – HCS01.1...W0006, W0013 and W0008	MSM019,031,041
RKL0013/000.0	configurable	1–75m		
RKL0014/005.0	fixed	5m	IndraDrive Cs – HCS01.1...W0006, W0013 and W0008	MSK030,040,050,060,061
RKL0014/000.0	configurable	1–75m		
RKL0019/005.0	fixed	5m	IndraDrive Cs – HCS01.1...W0018 and W0028	MSK030,040,050,060,061,076
RKL0019/010.0	fixed	10m		
RKL0019/000.0	configurable	1–75m		
RKL0050/000.0	configurable	1–75m	IndraDrive Cs – HCS01.1...W0054	MSK071E-0300
RKL4302/005.0	fixed	5m	IndraDrive C – HCS02.1...W0012, W0028, IndraDrive M - HMS01.1...W0020, W0036 and HMD01.1...W0012-W0036	MSK030,040,050,060,061,076
RKL4302/010.0	fixed	10m		
RKL4302/000.0	configurable	1–75m		
RKL4303/005.0	fixed	5m	IndraDrive C – HCS02.1...W0054, W0070 and HCS03.1...W0070, IndraDrive M - HMS01.1...W0054, W0070	MSK030,040,050,060,061,076
RKL4303/010.0	fixed	10m		
RKL4303/000.0	configurable	1–75m		
RKL4306/000.0	configurable	1–75m	IndraDrive C – HCS02.1...W0012, W0028, IndraDrive M - HMS01.1...W0020, W0036 and HMD01.1...W0012-W0036	MSK071E-0300
RKL4308/000.0	configurable	1–75m	IndraDrive C – HCS02.1...W0012, W0028, IndraDrive M - HMS01.1...W0020, W0036 and HMD01.1...W0012-W0036	MSK071E-0450
RKL4309/005.0	fixed	5m	IndraDrive C – HCS02.1...W0054, W0070 and HCS03.1...W0070, IndraDrive M - HMS01.1...W0054, W0070	MSK071E-0450
RKL4309/000.0	configurable	1–75m		
RKL4321/000.0	configurable	1–75m	IndraDrive C – HCS02.1...W0054, W0070 and HCS03.1...W0070, IndraDrive M - HMS01.1...W0054, W0070	MSK100B-0300 and MSK100C-0300
RKL4324/005.0	fixed	5m	IndraDrive C – HCS02.1...W0054, W0070 and HCS03.1...W0070, IndraDrive M - HMS01.1...W0054, W0070	MSK101D-0450
RKL4324/000.0	configurable	1–75m		
RKL4329/000.0	configurable	1–75m	IndraDrive C - HCS03.1...W0100, W0150 and IndraDrive M - HMS01.1...W0110-W0210	MSK101D-0450

1) Cables marked "fixed" are sized to the length stated; cables marked "configurable" can be ordered based on length needed within the range given and 0.5m increments

GoTo Focused Delivery Program: Drive Systems

## Cables (continued)

### Technical Data (continued)

Motor feedback cable	Length <sup>1)</sup>		Connecting	
			Drives	Motors
RKG4200/005.0	fixed	5m	IndraDrive C and Cs	any MSK motor
RKG4200/010.0	fixed	10m		
RKG4200/000.0	configurable	1-75m		
RKG0033/005.0	fixed	5m	IndraDrive Cs...W0006 and W0013	MSM019,031,041
RKG0033/000.0	configurable	1-75m		
RKG0034/000.0	configurable	1-2m	IndraDrive Cs...W0006 and W0013	MSM019,031,041 for absolute encoder function in conjunction with SUP-E01-MSM-BATTERYBOX

Interface cable (optical - Sercos II)	Length	Connecting
RKO0100/00.25	0.25m	Drives and peripherals with Sercos II (optical) communication interface, inside cabinet
RKO0101/005.0	5m	Drives and peripherals with Sercos II (optical) communication interface, outside cabinet
RKO0101/010.0	10m	

Interface cable (Ethernet based)	Length <sup>1)</sup>		Connecting
RKB0011/005.0	5m		Drives and peripherals with Sercos III or other Ethernet based communication interface
RKB0011/000.0	configurable	1-75m	
RKB0013/00.25	0.25m		

Interface cable (RS232 - Serial)	Length	Connecting
IKB0041/002.0	2m	A PC or a separate control terminal directly to the RS232 serial interface of the control unit for start-up or operation

Battery box	(HCS01.1 - MSM)	
SUP-E01-MSM-BATTERYBOX	External battery for absolute encoder function with HCS01.1 and MSM, connected in feedback circuit between RKG0033 and MSM or between RKG0033 and optional RKG0034	

Module bus extension	Length	Connecting
RKB0001/002.0	2m	Bus cable to transmit control signals where relatively large distances are between individual control units
RKB0001/005.0	5m	

1) Cables marked "fixed" are sized to the length stated; cables marked "configurable" can be ordered based on length needed within the range given and 0.5m increments

See index Page 69 for GoTo product and accessory part numbers.

GoTo Focused Delivery Program: Motion Control PAC

# IndraControl L



IndraControl L the rack-based platform from Rexroth allows easy and consistent automation for all centralized and distributed architectures.

IndraControl L is the flexible configurable hardware platform for open control architectures. Whether you intend to implement a motion control, a CNC or a PLC application – it is always the same hardware you use. Your application is only defined by the firmware.

For complete engineering and design information:  
GoTo [www.boschrexroth-us.com/GoToMotionControl\\_PAC](http://www.boschrexroth-us.com/GoToMotionControl_PAC)

## Features

- Scalable hardware platform
- Standardized communication interfaces
- Optional expansion through function and technology modules
- Ideal for centralized and distributed control
- Individually expandable with high-grade Human-Machine Interface (HMI) components
- Modular I/O units

## Technical Data

Control hardware		L40 IndraLogic 1G	L25 IndraLogic 2G	L45 IndraLogic 2G	L65 IndraLogic 2G
<b>Memory</b>					
Application:		64 MB	128 MB	256 MB	512 MB
Retentive memory:		128 kB	256 kB	256 kB	256 kB
Buffered:		1 MB	–	8 MB – optional / standard	8 MB – optional / standard
Flash size:		128 MB	1 GB	1 GB	1 GB
<b>Interfaces</b>					
Ethernet:		1 x Ethernet TCP/IP (Standard)			
Ready:		1 x ready contact (Standard)			
Others		–		2 x Ethernet TCP/IP	
<b>I/O</b>					
Digital inputs		8 DC-decoupled inputs (with interrupt capability)	–	8 DC-decoupled inputs (with interrupt capability)	
Digital outputs		8 DC-decoupled outputs		8 DC-decoupled outputs	
Channels, used	Max.	256			
I/O extension	Max. no. of Inline modules	63			
	Max. no. of bytes	64			
Function Modules	Max.	4	2	4	4
<b>Fieldbus</b>					
Sercos:		1 x Sercos II		1 x Sercos III	
ProfiNet:		–	–	1 x ProfiNet IO Controller/-Device (Option)	
EtherNet/IP:		–	–	1 x EtherNet/IP Scanner/-Adapter (Option)	
Profibus:		1 x Profibus-Master/-Slave		1 x Profibus-Master/-Slave	

See index Page 70 for GoTo product and accessory part numbers.



GoTo Focused Delivery Program: Motion Control PAC

# IndraControl L – Function Modules



IndraControl L function modules provide additional technology functions or fieldbus interfaces to the IndraControl L platform.

The number of function modules that can be used simultaneously depends on the control hardware and the IndraMotion system being utilized for the application.

For complete engineering and design information:  
**GoTo [www.boschrexroth-us.com/GoToMotionControl\\_PAC](http://www.boschrexroth-us.com/GoToMotionControl_PAC)**

## Technical Data

	<b>CFL01.1-Q2</b> Cross communication	<b>CFL01.1-R3</b> sercos III Interface	<b>CFL01.1-TP</b> Real-time-Ethernet / PROFIBUS
<b>Description</b>	sercos II fieldbus interface for real-time communication with drives or for redundant control cross communication	sercos III fieldbus interface for Ethernet-based real-time communication with drives and I/O peripherals, or for control cross communication	Fieldbus interface RT Ethernet (PROFINET RT, EtherNet/IP) and PROFIBUS
Adjustable ring cycle time	–	2 ms, 4 ms, 8 ms	–
Max. number of slaves	–	15, 31, 63	–
<b>Power supply</b>			
Internal	System bus		
Internal power consumption	2.05 W	2.3 W	1.65 W
<b>Mechanical data</b>			
Dimensions (W x H x D)	120 x 20 x 70 mm		
Protection category	IP20		

See index Page 70 for GoTo product and accessory part numbers.

GoTo Focused Delivery Program: Motion Control PAC

## IndraControl L – Function Modules



IndraControl L function modules provide additional technology functions or fieldbus interfaces to the IndraControl L platform.

The number of function modules that can be used simultaneously depends on the control hardware and the IndraMotion system being utilized for the application.

For complete engineering and design information:  
GoTo [www.boschrexroth-us.com/GoToMotionControl\\_PAC](http://www.boschrexroth-us.com/GoToMotionControl_PAC)

### Technical Data

	<b>CFL01.1–N1</b> Programmable Limit Switch
<b>Description</b>	Function interface, programmable limit switch, with 16 high-speed outputs for implementation of high speed cams for motion control applications
Adjustable ring cycle time	–
Max. number of slaves	–
<b>Power supply</b>	
Internal	System bus
Internal power consumption	2.8 W
External	24 V DC
Tolerance (without residual ripple)	–15/+20
Residual ripple	±5
U <sub>max</sub>	30 V
U <sub>min</sub>	19.2 V
Power consumption (max.)	4 A
<b>Digital outputs</b>	
Number	16
Connection method	1-wire
Output type	Semiconductor, no retaining
Output voltage, nominal	24 V DC
Rated output current	0.5 A
Lamp load at 8 Hz	5 W
Inductive load at 1 Hz	6.2 W (SG 1)
<b>Mechanical data</b>	
Dimensions (W x H x D)	120 x 20 x 70 mm
Protection category	IP20

See index Page 70 for GoTo product and accessory part numbers.

GoTo Focused Delivery Program: Motion Control PAC

# IndraMotion MLC



IndraMotion MLC is the integrated controller-based system solution from Rexroth. It uses PLC programming according to IEC 61131-3 with object oriented programming such as: Function Block Diagrams (FBD), Ladder Diagrams (LD), Sequential Function Chart (SFC), and Structured Text (ST).

The compact Rexroth IndraMotion MLC motion logic system gives you any freedom you wish for your consistent and modern machine automation. Innovative software and firmware functions, easy engineering and open system interfaces provide maximum flexibility in all motion applications.

For complete engineering and design information:  
GoTo [www.boschrexroth-us.com/GoToMotionControl\\_PAC](http://www.boschrexroth-us.com/GoToMotionControl_PAC)

## Technical Data

Control Hardware		MLC L40	MLC L25	MLC L45	MLC L65
<b>PLC runtime system</b>					
IndraLogic 1G kernel	Conforming with IEC 61131-3	●	—	—	—
IndraLogic 2G kernel	Conforming with IEC 61131-3 with extensions	—	●	●	●
<b>Task management</b>					
Freely projectable tasks (priority 0-20)	Cyclic, free-running, event-controlled, extern event-controlled	8			
Cycle-synchronous processing of the I/O process image		●			
sercos III synchronous processing of the I/O process image		●			
min. PLC cycle time	Synchronous with system cycle	1 ms			
min. Motion cycle time	Setpoint generator	1 ms	2 ms	1 ms	1 ms
<b>PLC processing time</b>					
Typical processing time for 1,000 instructions/μs	Command mix (Real, Integer, Bool etc.)	50	35	30	5
	Bool-Operation	50	20	30	5
	Word-Operation	50	20	30	5
<b>Motion Control</b>					
Number of axes	Real, virtual, encoder, grouping	32	16	32	64
Synchronization (ELS – electronic line shaft)	real axes (Servo drives)	●			
	Virtual axes (Virtual masters)	●			
	Encoder axes (Real masters)	●			
	real axes (Cross-communication)	●			
	Dynamic synchronization	●			
	Master axis cascading	●			
Positioning	Single-axis	●			
Electronic gears		●			
	Intermediate point tables (In the drive, max. 1,024 intermediate points)	4			
	Electronic Motion Profile (in the output drive, motion profiles with max. 16 segments)	2			
	FlexProfile (In the control, master-/time-based motion profiles with max. 16 segments)	4			
<b>Drive systems</b>					
IndraDrive		●	●	●	●
IndraDrive Mi	Firmware MPB	●	●	●	●
IndraDrive Cs		●	●	●	●
EcoDrive Cs		●	●	●	●
SERCOS Pack-Profile		●	●	●	●
HNC100.3	Hydraulic drive	●	●	●	●

See index Page 70 for GoTo product and accessory part numbers.

GoTo Focused Delivery Program: Motion Control PAC

# IndraLogic XLC



IndraLogic XLC (eXtended Logic Control) PLC system implements the latest PLC technology to provide substantial advantages for the intelligent automation. Object-oriented language extensions in programming enhance the quality of user programs through simplified modularization and accelerate the generation of machine variants. Scaling and open design of the IndraControl device families—L25 and L45—are the basis for flexible and application-oriented solutions in central or distributed control topologies. The universal, open real-time communications system Sercos III is the high-performance, high-functioning backbone among the system peripherals.

For complete engineering and design information:  
GoTo [www.boschrexroth-us.com/GoToMotionControl\\_PAC](http://www.boschrexroth-us.com/GoToMotionControl_PAC)

## Technical Data

Control Hardware		XLC L25	XLC L45
<b>PLC runtime system</b>			
IndraLogic 2G kernel	Conforming with IEC 61131-3 with extensions	●	●
<b>Task management</b>			
Freely projectable tasks (priority 0-20)	Cyclic, free-running, event-controlled, extern event-controlled		8
Cycle-synchronous processing of the I/O process image			●
Sercos III synchronous processing of the I/O process image			●
Min. PLC cycle time	Synchronous with system cycle		1 ms
Min. Motion cycle time	Setpoint generator	2 ms	1 ms
<b>PLC processing time</b>			
Typical processing time for 1,000 instructions/μs	Command mix (Real, Integer, Bool etc.)	35	30
	Bool-Operation	20	30
	Word-Operation	20	30
<b>Motion Control</b>			
Number of axes	Real, virtual, encoder, grouping	16	32
Synchronization (ELS – electronic line shaft)	real axes (Servo drives)		●
	Virtual axes (Virtual masters)		●
	Encoder axes (Real masters)		●
	real axes (Cross-communication)		●
	Dynamic synchronization		●
	Master axis cascading		●
	Positioning	Single-axis	
Electronic gears			●
	Intermediate point tables (In the drive, max. 1,024 intermediate points)		4
	Electronic Motion Profile (in the output drive, motion profiles with max. 16 segments)		2
	FlexProfile (In the control, master-/time-based motion profiles with max. 16 segments)		4
<b>Drive systems</b>			
IndraDrive C/M		●	●
IndraDrive Mi	Firmware MPB	●	●
IndraDrive Cs		●	●

See index Page 70 for GoTo product and accessory part numbers.

GoTo Focused Delivery Program: Safety Control

# SafeLogic compact

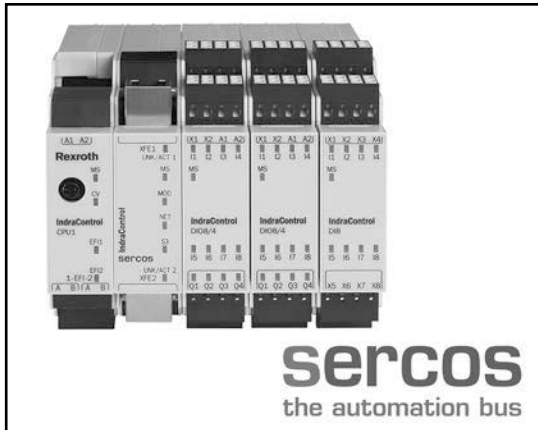

SafeLogic compact is a small safety control which features modular scalability, open architecture, user-friendly programming, and intuitive parameterization. It is designed for deployment in small and mid-size machines for a range of applications including machine tools, printing and processing, assembly and handling, packaging, and general automation.

For complete engineering and design information:  
GoTo [www.boschrexroth-us.com/GoToSafety](http://www.boschrexroth-us.com/GoToSafety)

## Features

- SafeLogic compact consists of the following:
  - main module SLC-3-CPU0 or SLC-3-CPU1
  - memory plug
  - up to 2 gateways
  - up to 12 additional extension modules (SLC-3-XTIO & SLC-3-XTID)
  - up to 8 UE410-2RO relay output modules and/or 4 UE410-4RO relay output modules

## Technical Data

Main System	
Type	Description
SLC-3-CPU000300	Main module CPU0, dual level spring clamp terminals
SLC-3-CPU130302	Main module CPU1, 2 EFI connections, dual level spring clamp terminals
SLC-3-GS3S00300	Sercos III Gateway (CSoS)
SLC-3-XTIO84302	Input/output extension, 8 inputs/4 outputs, dual level spring clamp terminals
SLC-3-XTID180302	Input extension, 8 inputs, dual level spring clamp terminals
SLC-A-UE410-2RO4	Output module, 2 NO contacts and 1 24 V DC signal output, plug-in block terminals
SLC-A-UE410-4RO4	Output module, 4 NO contacts and 2 24 V DC signal output, plug-in block terminals

Accessories	
Type	Description
SLC-A-UE10-2FG3D0	Safety relay: 2 NO, 1 NC, removable screw terminals
SLC-A-UE12-2FG3D0	Cascadable safety relay: 2 NO, 1 NC, removable screw terminals, with cascade plug
SLC-3-MPL000301	Memory plug
SLC-A-PLSET01	Connectors for I/O and relay modules, screw terminals
SLC-A-PLSET02	Connectors for I/O and relay modules, dual level spring clamp terminals
SLC-A-RS232/A/2.0	Configuration Cable, 2m, M8, Sub D
SWA-SLC**-SLD-01VRS-D0-CD650-COPY	SafeLogic Designer tool installation CD

See index Page 71 for GoTo product and accessory part numbers.

GoTo Focused Delivery Program: CNC

## IndraMotion MTX micro

	<p>IndraMotion MTX micro is the compact, simple, powerful, and nevertheless low-cost CNC solution from Rexroth for standard turning and milling machines. It consists of a custom HMI interface and a compact multi-axis drive controller with high-capacity CNC control and PLC.</p> <p>All of the functions required in small CNC machines are available. Up to 6 axes can be controlled in 2 CNC channels with minimum startup effort.</p> <p>For complete engineering and design information: GoTo <a href="http://www.boschrexroth-us.com/GoToCNC">www.boschrexroth-us.com/GoToCNC</a></p>
---	---

### Features

For detailed list of technical features for IndraMotion MTX micro go to <http://www.boschrexroth.com/mtxmico>

### Technical Data

Type	Description
HCT02.1E-W0025-A-03-B-L8-2S-D1-NN-NN-FW	3-axis unit with 1x I/O module
HCO02.1E-W0025-A-03-B-L8-1S-D1-D1-NN-FW	4-axis unit with 2x I/O modules
CFM01.1-01G0-N-LBA-01-FW	Compact Flash card – requires FWA <sup>1)</sup>
FWA-MICRO*-MTX-13VRS-NN	Firmware MTX13 <sup>1)</sup>
SWL-IWORKS-MTX-NNVRS-D0-MICRO	Engineering software license – single license <sup>1)</sup>
VDP80.1FKN-C1-NN-EN	Display panel Universal – requires VCH02-handwheel unit
VCH02.1NNN-000RS	Handwheel box, incl. cable and connector for VDP80.1
VDP80.1FGN-C1-NN-EN	Display panel for turning machines
RKB0030/000.0	Firewire cable – (connection HCO/HCT to VDP) – configurable length <sup>2)</sup> 1 – 10 meter
DEA40.1H	Digital I/O module for HCO/HCT <sup>3)</sup>
HLR01.1N-02K0-N15R0-A-007-NNNN	Bleeder resistor 2kW
HNL01.1E-0400-N0051-A-480-NNNN	Choke

1) Required items with MTX micro multi-axis unit

2) Cables referenced as configurable lengths can be ordered based on length needed within the range given and 0.5m increments

3) I/O module for add to existing I/O count on MTX micro unit or replacement

See index Page 71 for GoTo product and accessory part numbers.

GoTo Focused Delivery Program: CNC

# IndraMotion MTX

## CNC Control

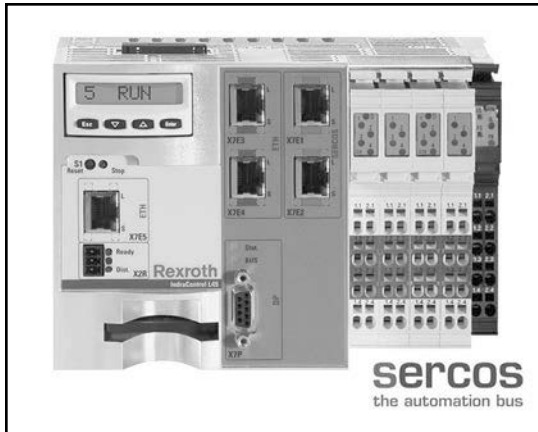

A complete CNC with integrated PLC for DIN rail mounting characterizes this control. Based on version chosen offering outstanding performance with a wide range of technology functions for special requirements.

For complete engineering and design information:  
**GoTo [www.boschrexroth-us.com/GoToCNC](http://www.boschrexroth-us.com/GoToCNC)**

### Features

For detailed list of technical features for IndraMotion MTX standard and IndraMotion MTX performance go to <http://www.boschrexroth.com/mtx>

### Technical Data

IndraMotion MTX	standard - universal CNC control	performance - high-performance CNC control
Default number of axes	8	8
Max. number of axes	8	64 (optional)
Max. number of spindles	2	32 (optional)
Default number of independent channels	2	3
Max. number of independent channels	2	12 (optional)
Control hardware	CML45.1-3P-504-NA-NNNN-NW	CML65.1-3P-504-NA-NNNN-NW

See index Page 71 for GoTo product and accessory part numbers.

GoTo Focused Delivery Program: I/O

## Inline – Power Modules

	<p>Compact modules utilizing spring-cage I/O connectors. Provide either 24 V DC to all PLC busses (Logic, Input, Output, Analog). Segment modules create separate “zone” of I/O to which power can be selectively cut-off.</p>
<p>For complete engineering and design information:  <b>GoTo <a href="http://www.boschrexroth-us.com/GoToIO">www.boschrexroth-us.com/GoToIO</a></b></p>	

### Features

- 2 available DC power modules to add only the power needed
- Wiring terminals easily removed, to allow module replacement without rewiring
- Single power module can provide up to 8A of 24 V DC power to PLC busses

### Technical Data

	R-IB IL PWR IN-PAC	R-IB IL 24 SEG/F-PAC	R-IB IL 24 SEG/F-D-PAC
<b>24-V power supply for generation of U<sub>L</sub> and U<sub>ANA</sub></b>			
Rated value	–	–	–
Permissible range	–	–	–
<b>Power consumption at nominal voltage</b>			
24-V module supply	–	–	–
Logic supply	Rated value	–	–
	Max. output current	–	–
Analog supply	Rated value	–	–
	Max. output current	–	–
Rated value	24 V DC	<b>Permissible total current in the potential terminals of the main and segment circuits</b>	
Permissible range	19.2 to 30 V		
Permissible current	Max. 8 A		
Nominal terminal current	–	6.0 A	
Max. permissible value	–	8.0 A	
<b>Electric data</b>			
Transmission speed	500 kbaud		
Error message to the higher level control system	–	Yes	
<b>Mechanical data</b>			
Dimensions (W x H x D)	12.2 x 120 x 71.5 mm		
Weight (without plug)	44 g		
Protection category	IP20		
Protection class	Class 3 according to VDE 0106, IEC 60536		–
Safety classification	–	Class 3 according to VDE 0106, IEC 60536	
Accessories	Connectors and labels included		

See index Page 72 for GoTo product and accessory part numbers.



GoTo Focused Delivery Program: I/O

# Inline – Bus Couplers

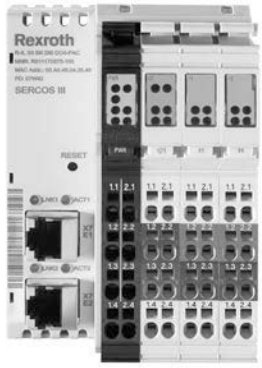

Sercos III and Profibus I/O bus couplers available. Bus couplers provide network drops that are expandable with using the same Inline I/O that is used locally with a PLC.

For complete engineering and design information:  
**GoTo [www.boschrexroth-us.com/GoToIO](http://www.boschrexroth-us.com/GoToIO)**

## Features

- Wiring terminals easily removed to allow module replacement without rewiring
- Sercos III bus coupler for an entire Sercos III automation bus architecture
- Configurable network speeds

## Technical Data

	R-IL S3 BK DI8 DO4-PAC	R-IL PB BK DI8 DO4/CN-PAC	R-IL PB BK DP/V1-PAC
<b>Communication</b>			
Interfaces	Sercos III	PROFIBUS DP Local bus	PROFIBUS DP
<b>System data</b>			
Number of segments per station	Max. 63 (incl. 2 at bus coupler)		Max. 63
Total of all I/O data per station	Max. 244 bytes		max 176/184 bytes, dep. mode
Transmission speed in the local bus	500 kbaud		Auto. to master speed
<b>Digital outputs</b>			
Number	4		–
Nominal output voltage U <sub>Out</sub>	24 VDC		–
Total current	2 A		–
Protection	Short-circuit, overload		–
Actuator connection type	2-, 3-wire connection		–
<b>Digital inputs</b>			
Number	8		–
Nominal input voltage U <sub>INom</sub>	24 VDC		–
Permissible nominal input voltage range	–30 < U <sub>INom</sub> < +30 VDC		–
Nominal input current at U <sub>INom</sub>	Typ. 3 mA		–
Permissible line length	30 m		–
Sensor connection type	2-, 3-wire connection		–
<b>Segment feed US/UM</b>			
Nominal value	24 VDC		
Tolerances	–15/+20 %		
Load current	Max. 8 A		
<b>Mechanical data</b>			
Dimensions (W x H x D)	80 x 121 x 70 mm		91 x 120 x 71.5 mm
Protection category	IP20		
Protection class	Class 3 according to VDE 0106, IEC 60536		
<b>Accessories</b>			
	Connectors and labels included		

See index Page 72 for GoTo product and accessory part numbers.

GoTo Focused Delivery Program: I/O

## Inline – Block I/O

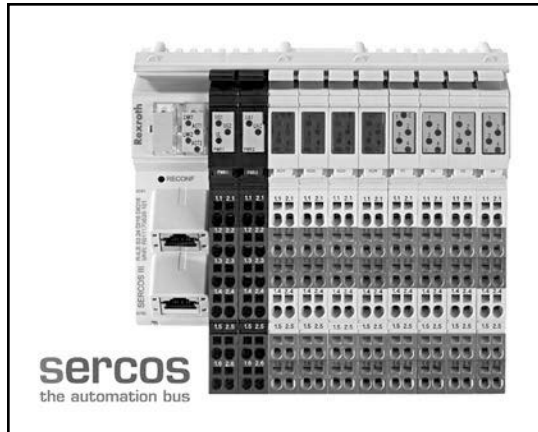

Rexroth Sercos III Inline Block is the ideal solution for applications with Block I/O requirements. The Sercos III block has built-in inputs and outputs. The compact design saves space and gives you additional options when you develop your automation solution.

For complete engineering and design information:  
GoTo [www.boschrexroth-us.com/GoToI/O](http://www.boschrexroth-us.com/GoToI/O)

### Features

- Cost-effective multi-wire connection technique
- Configurable network speeds
- Sercos III Block I/O provides 16 inputs and 16 configurable input/outputs

### Technical Data

		R-ILB S3 24 DI16 DIO16
<b>Communication</b>		
Interfaces		SERCOS III
<b>Digital inputs</b>		
Number		32 (16 fixed, 16 freely configurable)
Switching thresholds	Max. voltage at low level ULmax	< 5 V
	Max. voltage at high level UHmax	> 15 V
Nominal input voltage UINom		24 VDC
Permissible nominal input voltage range		-30 < UINom < +30 VDC
Nominal input current at UINom		Min. 3 mA
Permissible line length		30 m
Sensor connection type		2-, 3- wire connection
<b>Digital outputs</b>		
Number		16
Nominal output voltage UOut		24 VDC
Total current		8 A
Protection		Short-circuit/overload
Signal delay on activation of a		
nominal resistive load (12 Ω/48 W)		Typ. 500 μs
nominal lamp load (48 W)		Typ. 100 ms
nominal inductive load (1.2 H, 12 Ω)		Typ. 100 ms
Actuator connection type		2-, 3- wire connection
<b>Mechanical data</b>		
Dimensions (W x H x D)		156 x 141 x 55 mm
Protection category		IP20
Protection class		Class 3 according to VDE 0106, IEC 60536
<b>Accessories</b>		
		Connectors and labels included

See index Page 72 for GoTo product and accessory part numbers.

GoTo Focused Delivery Program: I/O

# Inline – Block I/O Analog

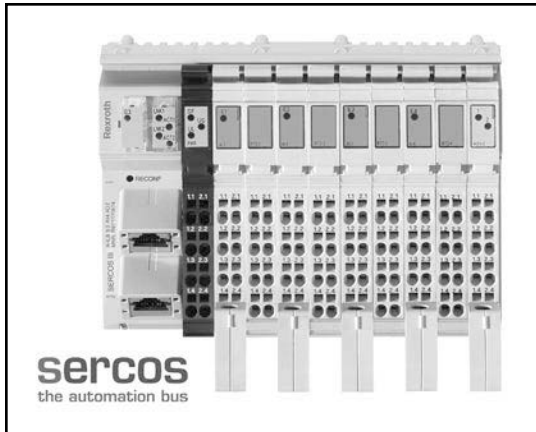

The R-ILB S3 AI4 AO2 module is designed for use within a SERCOS III network. It is used to acquire analog input signals and output analog signals.

For complete engineering and design information:  
GoTo [www.boschrexroth-us.com/GoToIO](http://www.boschrexroth-us.com/GoToIO)

## Features

- 2 x Ethernet twisted pair according to 802.3u with auto negotiation and auto crossing
- Transmission speed of 100 Mbps
- I/O areas can be parameterized individually for each channel
- 4 analog inputs
- 2 analog outputs

## Technical Data

		R-ILB S3 AI4 AO2
<b>Communication</b>		
Interfaces		Sercos III
<b>Analog inputs</b>		
Number		4 analog differential inputs
Conversion time of A/D converter		180 μs
Signal connection type		2-, 3- and 4-wire connection
<b>Analog differential voltage inputs</b>		
Number		4
Input range		0 to 10 V, ±10 V, 0 to 5 V, ±5 V
Input resistance		> 240 kΩ
<b>Analog differential current inputs</b>		
Number		4
Input range		0 to 20 mA, ±20 mA, 4 to 20 mA
Input resistance		< 100 Ω
<b>Analog differential RTD inputs</b>		
Number		4
Input range		PT 100, PT 500, PT 1,000, Ni 100, Ni 1,000 L&G, 0 to 2,500 Ω, 0 to 9.500 Ω
<b>Analog outputs</b>		
Number		2
Conversion time of D/A converter		Max. 70 μs
Output load :	Voltage output RLmin	2 kΩ
	Current output RLB	0 to 500 Ω
Signal connection type		2-wire connection
<b>Mechanical data</b>		
Dimensions (W x H x D)		156 x 141 x 55 mm
Protection category		IP20
Protection class		Class 3 according to VDE 0106, IEC 60536
<b>Accessories</b>		
		Connectors and labels included

See index Page 72 for GoTo product and accessory part numbers.

GoTo Focused Delivery Program: I/O

## Inline – Block I/O Analog SSI

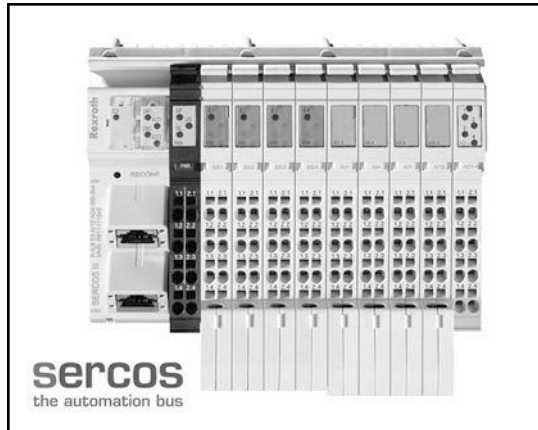

The R-ILB S3 AI12 AO4 SSI-IN4 module is designed for use within a SERCOS III network and acquiring analog input signals and output analog signals.

The SSI interfaces are used to read data from absolute encoders with SSI interface up to 31 bits. They support encoders with gray and binary code.

For complete engineering and design information:  
GoTo [www.boschrexroth-us.com/GoToIO](http://www.boschrexroth-us.com/GoToIO)

### Features

- 2 x Ethernet twisted pair according to 802.3u with auto negotiation and auto crossing
- Transmission speed of 100 Mbps
- I/O areas can be parameterized individually for each channel
- 12 analog inputs
- 4 analog outputs

### Technical Data

R-ILB S3 AI12 AO4 SSI-IN4	
<b>Communication</b>	
Interfaces	Sercos III
<b>Absolute value encoder inputs</b>	
Number	4
Encoder signals	Clock pulse, inverted clock pulse, data, inverted data (acc. to RS-422)
<b>Encoder types</b>	
Types	single-turn or multi-turn
Resolution	8 to 31 bits
Code type	2-, 3- and 4-wire connection
Encoder Supply	24 V DC
Current carrying capacity	Max. 200 mA
Transmission frequency	67.5 kHz, 100kHz, 125 kHz, 200 kHz, 250kHz, 300 kHz, 400 kHz, 500kHz, 600 kHz, 700 kHz, 800 kHz, 900kHz, 1 MHz, 2MHz, 4 MHz, (configurable)
<b>Analog differential inputs</b>	
Number	12
Input filter	10 kHz HW filter, averaging via software filter
Conversion time of A/D converter	75 $\mu$ s
Resolution of measurement	16 bits
Signal connection type	2-, 3- and 4-wire connection, shielded cable, twisted in pairs
<b>Voltage inputs</b>	
Measuring ranges	0 to 10 V, $\pm$ 10 V
Input resistance	> 260 k $\Omega$
<b>Current inputs</b>	
Measuring ranges	+10mA, 0 to 20 mA, $\pm$ 20 mA, 4 to 20 mA
Input resistance	< 240 $\Omega$

*continued on next page*

See index Page 72 for GoTo product and accessory part numbers.

GoTo Focused Delivery Program: I/O

## Inline – Block I/O Analog SSI (continued)

### Technical Data (continued)

		R-ILB S3 AI12 AO4 SSI-IN4
<b>Analog outputs</b>		
Number		4
Current ranges		+10mA, 0 to 20 mA, ±20 mA, 4 to 20 mA
Voltage ranges		0 to 10 V, ±10 V
Output load :	Voltage output $R_{L_{min}}$	2 k $\Omega$
	Current output $R_{LB}$	0 to 500 $\Omega$
Signal connection type		2-wire connection
<b>Mechanical data</b>		
Dimensions (W x H x D)		156 x 141 x 59 mm
Protection category		IP20
Protection class		Class 3 according to VDE 0106, IEC 60536
<b>Accessories</b>		
		Connectors and labels included

See index Page 72 for GoTo product and accessory part numbers.

GoTo Focused Delivery Program: I/O

## Inline – Digital Input Modules

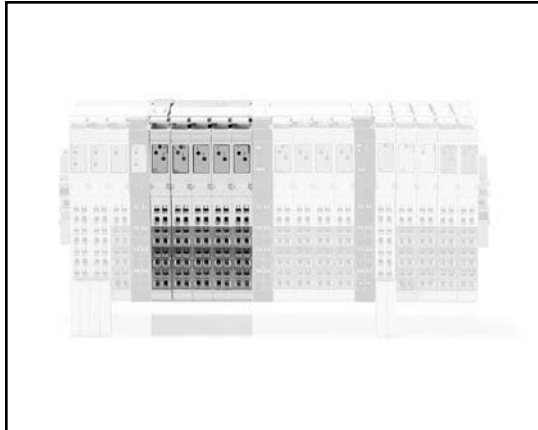

Modules of varying input counts, utilizing spring-cage I/O connectors. Buy only what you need. Only 24 V DC is available through GoTo program, but AC I/O is available.

For complete engineering and design information:  
GoTo [www.boschrexroth-us.com/GoToI/O](http://www.boschrexroth-us.com/GoToI/O)

### Features

- Input modules with up to 32 inputs available
- EDI module includes diagnostic LEDs
- Wiring terminals easily removed, to allow module replacement without rewiring
- 2-, 3-, 4-wire inputs available depending on your needs

### Technical Data

	R-IB IL 24 DI 4-PAC	R-IB IL 24 DI 8-PAC	R-IB IL 24 DI 8/HD-PAC	R-IB IL 24 DI 16-PAC	R-IB IL 24 DI 32/HD-PAC
<b>Digital inputs</b>					
Number	4	8	8	16	32
Switching thresholds	max. voltage at low level $U_{Lmax}$		< 5 V		< 5 V DC
	max. voltage at high level $U_{Hmax}$		> 15 V		> 15 V DC
Common potentials	Segment supply, ground				
Nominal input voltage $U_{INom}$	24 V DC				
Nominal input current at $U_{INom}$	Min. 3 mA				2.8 mA
Delay time $t_{On}$	–				2 ms
Delay time $t_{Off}$	–				4 ms
Permissible line length	30 m				
Sensor connection type	2-, 3- or 4-wire	2-, 3- or 4-wire	1-wire	2-, 3-wire	1-wire
<b>Electric data</b>					
Logic voltage $U_L$	7.5 V				
Power consumption from local bus $U_L$	40 mA	50 mA		60 mA	90 mA
Nominal current consumption from $U_S$	Max. 1.0 A	Max. 2.0 A		Max. 4.0 A	–
<b>Mechanical data</b>					
Dimensions (W x H x D)	12.2 x 141 x 71.5 mm	48.8 x 120 x 71.5 mm	12.2 x 141 x 71.5 mm	48.8 x 141 x 71.5 mm	48.8 x 120 x 71.5 mm
Protection category	IP20				
Protection class	Class 3 according to VDE 0106, IEC 60536				
Accessories	Connectors and labels included				

See index Page 72 for GoTo product and accessory part numbers.

GoTo Focused Delivery Program: I/O

# Inline – Digital Output Modules

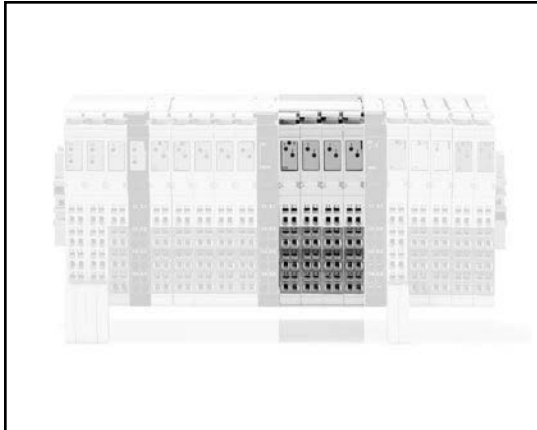

Modules of varying output counts, utilizing spring-cage I/O connectors. Buy only what you need. 24 V DC, 120 V AC and 240 V AC available.

For complete engineering and design information:  
GoTo [www.boschrexroth-us.com/GoToIO](http://www.boschrexroth-us.com/GoToIO)

## Features

- Output modules with up to 32 outputs available
- Transistor, Triac, Relay outputs available
- Wiring terminals easily removed to allow module replacement without rewiring
- Single-, 2-, 3-, 4-wire outputs available depending on your needs

## Technical Data

		R-IB IL 24 DO 2-2A	R-IB IL 24 DO 4-PAC	R-IB IL 24 DO 8-PAC	R-IB IL 24 DO 8/HD-PAC	R-IB IL 24 DO 8-2A-PAC	R-IB IL 24 DO 16-PAC	R-IB IL 24 DO 32/HD-PAC	
<b>Digital outputs</b>									
Number		2	4	8			16	32	
Nominal output voltage $U_{Out}$		24 V DC							
Nominal current $I_{Nom}$ per channel		2 A	0.5 A			2 A	0.5 A		
Total current		4 A	2 A	4 A		8 A (at 50 % synchronism)	8 A		
Protection		Short-circuit/overload							
Signal delay upon power on of	nominal resistive load (12 $\Omega$ /48 W)	Typ. 200 $\mu$ s	Typ. 100 $\mu$ s		Typ. 500 $\mu$ s	Typ. 50 $\mu$ s	Typ. 500 $\mu$ s		
	nominal lamp load (48 W)	Typ. 200 ms	Typ. 100 ms			Typ. 75 ms	Typ. 100 ms		
	nominal inductive load (1.2 H, 12 $\Omega$ )	Typ. 250 ms	Typ. 100 ms			Typ. 50 ms	Typ. 100 ms		
Signal delay upon power down of	nominal resistive load (12 $\Omega$ /48 W)	Typ. 200 $\mu$ s	Typ. 1 ms			Typ. 500 $\mu$ s	Typ. 1 ms		
	nominal lamp load (48 W)	Typ. 200 $\mu$ s	Typ. 1 ms			Typ. 500 $\mu$ s	Typ. 1 ms		
	nominal inductive load (1.2 H, 12 $\Omega$ )	Typ. 250 ms	Typ. 50 ms			Typ. 150 ms	Typ. 50 ms		
Actuator connection type		2-, 3- or 4-wire	2-, 3-wire	2-, 3- or 4-wire	1-wire	2-, 3- or 4-wire	2-, 3-wire	1-wire	
<b>Electric data</b>									
Logic voltage		7.5 V							
Power consumption from local bus $U_L$		Max. 35 mA	Max. 44 mA	Max. 60 mA	Max. 45 mA	Max. 60 mA	Max. 90 mA	Max. 140 mA	
Segment supply voltage $U_S$		24 V DC (nominal value)							
Nominal current consumption from $U_S$		Max. 4 A (2 x 2 A)	Max. 2 A (2 x 0.5 A)	Max. 4 A (8 x 0.5 A)		Max. 8 A	Max. 8 A (16 x 0.5 A)	Max. 8 A (16 x 0.5 A or 32 x 0.25 A)	
Error message to the higher level control system		Short-circuit/overload of an output				–	Short-circuit/overload of an output		

See index Page 72 for GoTo product and accessory part numbers.

*continued on next page*

GoTo Focused Delivery Program: I/O

## Inline – Digital Output Modules (continued)

### Technical Data (continued)

	R-IB IL 24 DO 2-2A	R-IB IL 24 DO 4-PAC	R-IB IL 24 DO 8-PAC	R-IB IL 24 DO 8/HD-PAC	R-IB IL 24 DO 8-2A-PAC	R-IB IL 24 DO 16-PAC	R-IB IL 24 DO 32/HD-PAC
<b>Mechanical data</b>							
Dimensions (W x H x D)	12.2 x 120 x 71.5 mm	12.2 x 141 x 71.5 mm	48.8 x 120 x 71.5 mm	12.2 x 120 x 71.5 mm	48.8 x 120 x 71.5 mm	48.8 x 141 x 71.5 mm	48.8 x 120 x 71.5 mm
Protection category	IP20						
Protection class	Class 3 according to VDE 0106, IEC 60536						
Accessories	Connectors and labels included						

	R-IB IL 24/230 DOR 1/W-PAC	R-IB IL 24/230 DOR 4/W-PAC
<b>Relay output</b>		
Number	1	4
Max. switching voltage	253 V AC, 250 V DC	
Max. switching capacity	750 VA	
<b>Electric data</b>		
Logic voltage U <sub>L</sub>	7.5 V	
Power consumption from local bus U <sub>L</sub>	Max. 60 mA	Max. 187 mA
Operating mode: process data mode	2 bits	2 bits
Transmission speed	500 kbaud	
<b>Ambient conditions</b>		
Permissible temperature (operation)	-25 to +55 °C	
Permissible temperature (storage)	-25 to +85 °C	
Permissible relative humidity (operation)	5 to 90 %	
Permissible relative humidity (storage)	5 to 95 %	
<b>Mechanical data</b>		
Dimensions (W x H x D)	12.2 x 120 x 71.5 mm	
Weight (without plug)	46 g	
Protection category	IP20	
Protection class	Class 3 according to VDE 0106, IEC 60536	
Accessories	Connectors and labels included	

See index Page 72 for GoTo product and accessory part numbers.



GoTo Focused Delivery Program: I/O

# Inline – Analog Input Modules

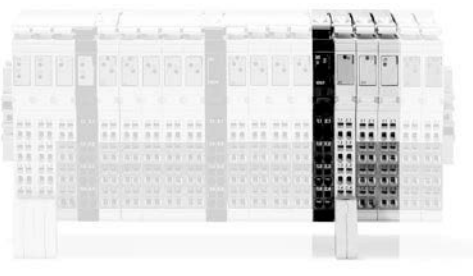

1 – 8 channel modules available. Spring-cage wired. Voltage and Current I/O available.

For complete engineering and design information:  
**GoTo [www.boschrexroth-us.com/GoToIO](http://www.boschrexroth-us.com/GoToIO)**

## Features

- Wiring terminals easily removed to allow module replacement without rewiring
- Adjustable resolution
- Programmable output formats
- High-speed processing available

## Technical Data

	R-IB IL AI 2/SF-PAC	R-IB IL AI 8/IS-PAC	R-IB IL AI 8/SF-PAC
<b>Analog inputs</b>			
Number	2 analog single-ended inputs	8 analog single-ended inputs	
Digital filtering (averaging)	Across 16 measurement values (can be switched off)	None or across 4, 16 or 32 measurement values	
Conversion time of A/D converter	Typ. 120 µs	Max. 10 µs	
<b>Voltage inputs</b>			
Measuring ranges	0 to 10 V, ±10 V	–	0 to 10 V, ±10 V, 0 to 5 V, ±5 V, 0 to 25 V, ±25 V, 0 to 50 V
Process data update of either channel	< 1.5 ms	–	< 1.5 ms
<b>Current inputs</b>			
Measuring ranges	0 to 20 mA, ±20 mA, 4 to 20 mA	0 to 20 mA, 4 to 20 mA, ±20 mA, 0 to 40 mA, ±40 mA	
Process data update of either channel	< 1.5 ms	Synchronous with the bus	< 1.5 ms
Max. permissible current in each input	±100 mA		
Resolution	16 Bit		
Sensor connection type	2-, 3-wire connection		2-wire connection
<b>Electric data</b>			
Logic voltage U <sub>L</sub>	7.5 V		
Power consumption from local bus U <sub>L</sub>	Typ. 45 mA	Typ. 52 mA, max. 65 mA	Typ. 48 mA, max. 55 mA
Peripheral supply voltage U <sub>ANA</sub>	24 V DC		
Power consumption at U <sub>ANA</sub>	Typ. 12 mA	Typ. 31 mA, max. 40 mA	Typ. 30 mA, max. 35 mA
<b>Mechanical data</b>			
Dimensions (W x H x D)	12.2 x 135 x 71.5 mm	48.8 x 135 x 71.5 mm	48.8 x 120 x 71.5 mm
Protection category	IP20		
Protection class	Class 3 according to VDE 0106, IEC 60536		
Accessories	Connectors and labels included		

See index Page 72 for GoTo product and accessory part numbers.

GoTo Focused Delivery Program: I/O

## Inline – Analog Output Modules

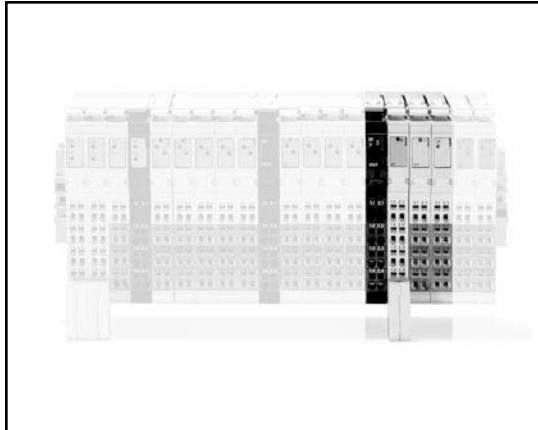

1 or 2 channel modules available. Spring-cage wired. Voltage and Current Output available. 16-bit resolution. Easy to set up.

For complete engineering and design information:  
GoTo [www.boschrexroth-us.com/GoToIO](http://www.boschrexroth-us.com/GoToIO)

### Features

- Wiring terminals easily removed to allow module replacement without rewiring
- Adjustable resolution
- Programmable output formats
- High-speed processing available
- Only 1 data register required to configure module

### Technical Data

	R-IB IL AO 2/U/BP-PAC	R-IB IL AO 1/SF-PAC	R-IB IL AO 2/SF-PAC
<b>Analog outputs</b>			
Number	2 single-ended outputs	1, automatically configured in relation to the terminal point used	2, automatically configured in relation to the terminal point used
Current ranges	–	0 to 20 mA, 4 to 20 mA	
Voltage ranges	–10 to +10 V/0 to +10 V	0 to 10 V	
<b>Output load</b>			
Resolution	16 bits		
Process data update including conversion time of D/A converter	< 1 ms		
Actuator connection type	2-wire connection		
<b>Electric data</b>			
Logic voltage $U_L$	7.5 V		
Power consumption from local bus $U_L$	Typ. 33 mA, max. 40 mA		Typ. 36 mA, max. 45 mA
Peripheral supply voltage $U_{ANA}$	24 V DC		
Power consumption at $U_{ANA}$	Typ. 25 mA, max. 35 mA	Typ. 50 mA, max. 65 mA	Typ. 75 mA, max. 95 mA
Error message to the higher level control system	Failure or logic voltage $U_L$ not reached		Failure of supply voltage $U_{ANA}$
<b>Mechanical data</b>			
Dimensions (W x H x D)	12.2 x 135 x 71.5 mm	24.4 x 135 x 71.5 mm	48.8 x 135 x 71.5 mm
Protection category	IP20		
Protection class	Class 3 according to VDE 0106, IEC 60536		
Accessories	Connectors and labels included		

See index Page 72 for GoTo product and accessory part numbers.

GoTo Focused Delivery Program: I/O

## Inline – Temperature Modules



2, 4, 8 channel modules available. Can read full range of standard thermocouples and resistive inputs. Spring-cage I/O connectors utilized for easy wiring.

For complete engineering and design information:  
GoTo [www.boschrexroth-us.com/GoToIO](http://www.boschrexroth-us.com/GoToIO)

### Features

- Pt, Ni, Cu, KTY, linear resistors can be used with RTD modules
- B, C, E, J, K, L, N, R, S, T, U, W, thermocouples can be used with UTH
- 2-, 3-wire inputs available depending on your needs

### Technical Data

	R-IB IL TEMP 2 RTD-PAC	R-IB IL TEMP 2 UTH-PAC
<b>Analog inputs</b>		
Number	2 inputs for resistive temperature sensors	2 inputs for thermocouples or linear voltages
Usable sensor types	Pt, Ni, Cu, KTY	B, C, E, J, K, L, N, R, S, T, U, W, HK
Conversion time of A/D converter	Typ. 120 $\mu$ s	Typ. 120 $\mu$ s
Voltage input range	–	–15 to +85 mV
Process data update	Depending on connection method	Max. 30 ms for either channel
Both channels acc. to two-wire principle	20 ms	–
One channel acc. to two-wire principle, one channel acc. to four-wire principle	20 ms	–
Both channels acc. to three-wire principle	32 ms	–
Limit frequency of analog filter	–	48 Hz
Sensor connection type	2-, 3- or 4-wire connection	2-wire connection
<b>Electric data</b>		
Logic voltage $U_L$	7.5 V	
Power consumption from local bus $U_L$	Typ. 43 mA	
Peripheral supply voltage $U_{ANA}$	24 V DC	
Power consumption at $U_{ANA}$	Typ. 11 mA	
Error message to the higher level control system	Failure of supply voltage $U_{ANA}$ , peripheral/user error	
<b>Mechanical data</b>		
Dimensions (W x H x D)	12.2 x 135 x 71.5 mm	
Protection category	IP20	
Protection class	Class 3 according to VDE 0106, IEC 60536	
Accessories	Connectors and labels included	

See index Page 72 for GoTo product and accessory part numbers.

GoTo Focused Delivery Program: I/O

## Inline – Communication Modules

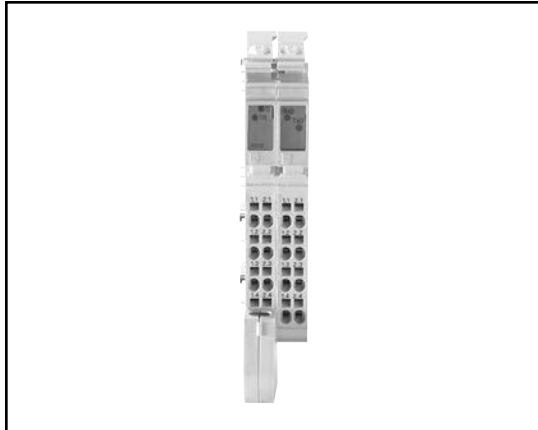

These Communication modules are designed for use within an Inline station. It is used to operate standard I/O devices with serial interfaces on a bus system. Parameterization and data exchange is carried out via the bus using process data.

For complete engineering and design information:  
GoTo [www.boschrexroth-us.com/GoToIO](http://www.boschrexroth-us.com/GoToIO)

### Features

- 4 KB receive buffer and 1 KB transmit buffer
- Wiring terminals easily removed to allow module replacement without rewiring
- Serial modules can be configured to read and write different frames and baud rates
- Diagnostic and status indicators

### Technical Data

	R-IB IL RS 232-PRO-PAC	R-IB IL RS 485/422-PRO-PAC
<b>Serial interface</b>		
Type	V.24 interface with DTR/CTS handshake, designed as data terminal equipment (DTE), electric data acc. to EIA (RS) 232, CCITT V.28, DIN 66259 Part 1	Half-duplex RS485 or full-duplex RS422, electrical data acc. to EIA (RS) 485, EIA (RS) 422, CCITT V.11
Transmission rate adjustable to	38.4 kbaud	37.5 kbaud
Receiver buffer	4 kbytes	
Transmitter buffer	1 kbyte	
<b>24 V infeed for generation of U<sub>L</sub> and U<sub>ANA</sub></b>		
Rated value	—	
Permissible range	—	
<b>24 V peripheral supply (main circuit U<sub>M</sub>)</b>		
Rated value	—	
Permissible range	—	
Permissible current	—	
<b>Electric data</b>		
Logic voltage U <sub>L</sub>	7.5 V	
Power consumption from local bus U <sub>L</sub>	Typ. 170 mA	
<b>Mechanical data</b>		
Dimensions (W x H x D)	24.4 x 120 x 71.5 mm	24.4 x 135 x 71.5 mm
Protection category	IP20	
Protection class	Class 3 according to VDE 0106, IEC 60536	
Accessories	Connectors and labels included	

See index Page 72 for GoTo product and accessory part numbers.

GoTo Focused Delivery Program: I/O

## Inline – Motion and Counter Modules



Compact modules utilizing spring-cage I/O connectors. Provide the capability to do basic motion control without resorting to complex motion-controller PLCs. Step and direction control of steppers is also available.

For complete engineering and design information:  
GoTo [www.boschrexroth-us.com/GoToIO](http://www.boschrexroth-us.com/GoToIO)

### Features

- Wiring terminals easily removed to allow module replacement without rewiring
- Inputs can read from 5 V DC to 24 V DC inputs
- Incremental and Absolute Encoder Input modules available
- CNT module can count events, calculate frequency and generate pulse streams

### Technical Data

	R-IB IL CNT-PAC— counter module	R-IB IL INC-IN-PAC— incremental-encoder module	R-IB IL SSI-PAC— SSI module
<b>Digital inputs</b>			
Number	4	3	4
Nominal input voltage $U_{In}$	24 V DC		
Nominal input current $I_{In}$	5 mA	Typ. 2.7 mA	Typ. 5 mA
<b>Switching output</b>			
Number	1	—	
<b>Digital outputs</b>			
Number	—	1 (double assignment of input E3)	4
Nominal output voltage $U_{Out}$	—		24 V DC
Nominal current per output $I_{Nom}$	—		0.5 A
<b>Electric data</b>			
Logic voltage $U_L$	7.5 V		
Power consumption from local bus $U_L$	Typ. 40 mA, max. 50 mA	Max. 70 mA	Max. 60 mA
Nominal voltage $U_S$	24 V DC		
Nominal current consumption at $U_S$	Max. 1 A	Typ. 340 mA	Max. 2 A
Error message to the higher level control system	Short-circuit/overload of sensor supply		Failure or overload of encoder supply/no encoder connected/core break at one of the encoder lines
<b>Mechanical data</b>			
Dimensions (W x H x D)	24.4 x 135 x 71.5 mm	24.4 x 141 x 71.5 mm	48.8 x 141 x 71.5 mm
Protection category	IP20		
Protection class	Class 3 according to VDE 0106, IEC 60536		

See index Page 72 for GoTo product and accessory part numbers.

GoTo Focused Delivery Program: I/O

## Inline – PWM Output Module

	<p>The terminal is designed for use within an inline station. It can be used in the four different operating modes: PWM (pulse width modulation), frequency generator, single shot (single pulse generator), and pulse direction signal.</p> <p>For complete engineering and design information:  <b>GoTo <a href="http://www.boschrexroth-us.com/GoToIO">www.boschrexroth-us.com/GoToIO</a></b></p>
---	--

### Features

- Two independently operating channels
- Output signals as 5 V or 24 V signals
- Short-circuit protected and overload protected outputs
- Diagnostic and status indicators

### Technical Data

		R-IB IL PWM/2-PAC
<b>Digital outputs 24 V DC</b>		
Number		2
Nominal output voltage $U_{Out}$		24 V DC
Differential voltage at $I_{Nom}$		$\leq 1$ V
Nominal current $I_{Nom}$ per channel		0.5 A
Nominal current tolerances		10%
Protection		Short-circuit/overload
Signal delay upon power up of:	Nominal resistive load (12 $\Omega$ /48 W)	Typ. 80 $\mu$ s
	Nominal lamp load (48 W)	Typ. 100 $\mu$ s
	Nominal inductive load (1.2 H, 12 $\Omega$ )	Typ. 150 $\mu$ s
Signal delay upon power down of:	Nominal resistive load (12 $\Omega$ /48 W)	Max. 500 Hz
	Nominal lamp load (48 W)	Max. 500 Hz
	Nominal inductive load (1.2 H, 12 $\Omega$ )	Max. 0.3 Hz
Actuator connection type		2-wire and 3-wire connection
<b>Digital outputs 5 V DC</b>		
Number		2
Nominal output voltage $U_{Out}$		5 V DC
Differential voltage at $I_{Nom}$		0.5 V
Nominal current $I_{Nom}$ per channel		10 mA
Nominal current tolerances		10%
Protection		Short-circuit/overload
Signal delay upon power up of nominal resistive load		2 $\mu$ s
Signal delay upon power down of nominal resistive load		2 $\mu$ s
Switching frequency at a nominal resistive load		50 kHz

See index Page 72 for GoTo product and accessory part numbers.

*continued on next page*

GoTo Focused Delivery Program: I/O

## Inline – PWM Output Module (continued)

### Technical Data (continued)

Electrical data	
Logic voltage $U_L$	7.5 V
Power consumption from local bus $U_L$	130 mA
Nominal voltage $U_S$	24 V DC
Nominal current consumption from $U_S$	Max. 1 A
Error message to the higher-level control system	Short-circuit/overload of sensor supply
Mechanical data	
Dimensions (W x H x D)	24.4 x 135 x 71.5 mm
Protection category	IP20
Protection class	Class 3 according to VDE 0106, IEC 60536
Accessories	Connectors and labels included

See index Page 72 for GoTo product and accessory part numbers.

GoTo Focused Delivery Program: I/O

## IndraControl S67 – Power Divider



Feed Module – For supplying IndraControl S67 components mounted on the machine with 24 V DC for expansion of the I/O system.

For complete engineering and design information:  
GoTo [www.boschrexroth-us.com/GoToI/O](http://www.boschrexroth-us.com/GoToI/O)

### Features

- Allow for one 24V DC cable run out to the machine for I/O power distribution
- IP 67 rating for harsh machine environments

### Technical Data

<b>Power Divider</b>	<b>S67-PWR-IN-M12</b>
Connection type	M23 connectors, 6 poles
<b>Supply voltage</b>	
Logic and sensor voltage $U_{LS}$	24 V DC (–25 to +30%)
Actuator Voltage $U_A$	24 V DC (–25 to +30%)
<b>Supply current</b>	
Logic and sensor current $I_{LS}$	Typ. 4 mA
Actuator current $I_A$	Typ. 4 mA
<b>Supply outputs</b>	
Number	6
Connection type	M12 connectors, A coded, 4 poles
Current carrying capacity (connector)	Max. 8 A ( $U_{LS}$ : 4 A, $U_A$ : 4 A)
Current carrying capacity (module)	Max. 24 A ( $U_{LS}$ : max. 8 A, $U_A$ : max. 16 A)
Short circuit protection	No
<b>Electrical isolation</b>	
$U_{LS} - U_A$	500 V DC
<b>Ambient conditions</b>	
Permissible temperature (operation)	–25 to +80 °C
Permissible relative humidity (operation)	5 to 95 %
Permissible air pressure (operation)	795 to 1,080 hPa
<b>Mechanical data</b>	
Dimensions (W x H x D)	50 x 117 x 35 mm
Dimensional drawing	Type 2
Weight	240 g
Protection class	IP67 (NEMA 6&6P), DIN40050 (EN60529)
Vibration resistance	According to IEC 60068-2-6
Shock resistance (temporary)	According to IEC 60068-2-27
<b>LED indicators</b>	
$U_{LS} + U_A$ – Supply status	LED (green)
LED indicators	Non-latching

See index Page 73 for GoTo product and accessory part numbers.



GoTo Focused Delivery Program: I/O

# IndraControl S67 – Bus Coupler

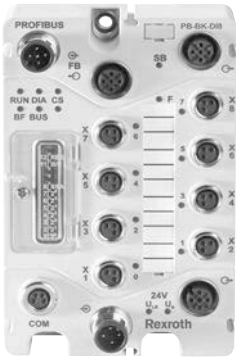
	<p>IP67 Fieldbus Coupler – Mounted on the machine for connecting local I/O modules to a higher-level fieldbus system.</p> <p>For complete engineering and design information: GoTo <a href="http://www.boschrexroth-us.com/GoToIO">www.boschrexroth-us.com/GoToIO</a></p>
---	---

## Features

- 8 on board inputs included with the Profibus bus coupler
- Built in status light to troubleshoot module out on the machine
- Up to 64 I/O modules can be operated from a single Fieldbus coupler

## Technical Data

<b>Fieldbus coupler</b>	<b>S67-PB-BK-DI8-M8</b>
Type	PROFIBUS slave
Connection type	M12 connectors, B coded, 5 poles
Transmission speed	12 Mbit/s (automatic recognition)
<b>Digital inputs</b>	
Number	8
Connection type	M8 connectors, A coded, 3 poles
Sensor connection type	2-, 3-wire connection
Input filter	Parametrizable
Input characteristic	Type 1, acc. to IEC 61131-2
Signal voltage (0)	-30 to +5 V DC
Signal voltage (1)	+11 to +30 V DC
Input circuit	High-side switching
Input voltage	24 V DC (-30 < U <sub>IN</sub> < +30 V DC)
Input current	Typ. 2.8 mA
Cable length, unshielded	≤ 30 m
<b>Process image</b>	
Input process image	244 byte
Output process image	244 byte
<b>Ambient conditions</b>	
Permissible temperature (operation)	-25 to +60 °C
Permissible relative humidity (operation)	5 to 95 %
Permissible air pressure (operation)	795 to 1,080 hPa
<b>Mechanical data</b>	
Dimensions (W x H x D)	75 x 117 x 35 mm
Dimensional drawing	Type 1
Weight	330 g
Protection class	IP67 (NEMA 6&6P), DIN40050 (EN60529)
Vibration resistance	According to IEC 60068-2-6
Shock resistance (temporary)	According to IEC 60068-2-27

See index Page 73 for GoTo product and accessory part numbers.

GoTo Focused Delivery Program: I/O

## IndraControl S67 – Digital Input Modules



IP67 Digital Input Modules – Mounted on the machine for acquiring digital signals, e.g. buttons limit or proximity switches.

For complete engineering and design information:  
GoTo [www.boschrexroth-us.com/GoToIO](http://www.boschrexroth-us.com/GoToIO)

### Features

- Expandable to 500 m per I/O station
- M12 and M8 connection technology in compact housing design

### Digital Inputs

Technical data	S67-DI8-M8	S67-DI8-M12
<b>Digital inputs</b>		
Number	8	4
Connection type	M8 connectors, A coded, 3 poles	M12 connectors, A coded, 5 poles
Sensor connection type	2-, 3-wire connection	2-, 3-wire connection
Input filter	Parametrizable	Parametrizable
Input characteristic	Type 2, acc. to IEC 61131-2	Type 2, acc. to IEC 61131-2
Signal voltage (0)	-30 to +5 V DC	-30 to +5 V DC
Signal voltage (1)	+11 to +30 V DC	+11 to +30 V DC
Input circuit	High-side switching	High-side switching
Input voltage	24 VDC (-30 V DC < U <sub>IN</sub> < +30 V DC)	24 VDC (-30 V DC < U <sub>IN</sub> < +30 V DC)
Input current	Typ. 7.3 mA	Typ. 7.3 mA
Cable length, unshielded	≤ 30 m	≤ 30 m
<b>Configurable functions</b>		
Input filter (per channel)	0.1/0.5/3/15/20 ms/filter off	0.1/0.5/3/15/20 ms/filter off
Online simulation (per channel)	Lock/unlock; simulation value: 0/1	Lock/unlock; simulation value: 0/1
Diagnostics (per module)	Overload and short circuit (sensor supply), Undervoltage (U <sub>LS</sub> + U <sub>A</sub> )	Overload and short circuit (sensor supply), Undervoltage (U <sub>LS</sub> + U <sub>A</sub> )
<b>Process image</b>		
Process data width	1 byte data + status	1 byte data + status
<b>Ambient conditions</b>		
Permissible temperature (operation)	-25 to +60 °C	-25 to +60 °C
Permissible relative humidity (operation)	5 to 95 %	5 to 95 %
Permissible air pressure (operation)	795 to 1,080 hPa	795 to 1,080 hPa
<b>Mechanical data</b>		
Dimensions (W x H x D)	50 x 117 x 35 mm	50 x 117 x 35 mm

See index Page 73 for GoTo product and accessory part numbers.

GoTo Focused Delivery Program: I/O

# IndraControl S67 – Digital Output Modules



IP67 Digital Output Modules – Mounted on the machine for outputting digital signals, e.g. status lights or actuators.

For complete engineering and design information:  
**GoTo [www.boschrexroth-us.com/GoToIO](http://www.boschrexroth-us.com/GoToIO)**

## Features

- Expandable to 500 m per I/O station
- M12 and M8 connection technology in compact housing design

## Digital Outputs

Technical data	S67-DO8-M8	S67-DO8-M12	S67-DO8-M8-2A	S67-DO8-M12-2A
<b>Digital outputs</b>				
Number	8	8	8	8
Connection type	M8 connectors, 3 poles	M12 connectors, 5 poles	M8 connectors, 3 poles	M12 connectors, 5 poles
Sensor connection type	2-, 3-wire connection	2-, 3-wire connection	2-, 3-wire connection	2-, 3-wire connection
Output voltage	$\leq U_A$	$\leq U_A$	$\leq U_A$	$\leq U_A$
Output current (per channel)	0.5 A (max. 0.6 A), short-circuit/overload proof (thermal disconnection)	0.5 A (max. 0.6 A), short-circuit/overload proof (thermal disconnection)	2.0 A (max. 2.4 A), short-circuit/overload proof (thermal disconnection)	0.5 A (max. 0.6 A), short-circuit/overload proof (thermal disconnection)
Voltage drop against $U_A$ at 500 mA	Max. 0.2 V DC	Max. 0.2 V DC	Max. 0.2 V DC	Max. 0.2 V DC
Output current (module)	Max. 4 A	Max. 4 A	Max. 8 A	Max. 8 A
Switching-on of overload circuit	Parametrizable	Parametrizable	Parametrizable	Parametrizable
Output circuit	High-side switching	High-side switching	High-side switching	High-side switching
<b>Information on selecting the actuator</b>				
Rise time from 0 to 1	Typ. 40 $\mu$ s (resistive load)	Typ. 40 $\mu$ s (resistive load)	Typ. 30 $\mu$ s (resistive load)	Typ. 30 $\mu$ s (resistive load)
Rise time from 1 to 0	Typ. 50 $\mu$ s (resistive load)	Typ. 50 $\mu$ s (resistive load)	Typ. 50 $\mu$ s (resistive load)	Typ. 50 $\mu$ s (resistive load)
Cable length (unshielded)	$\leq 30$ m	$\leq 30$ m	$\leq 30$ m	$\leq 30$ m
<b>Configurable functions</b>				
Substitute value strategy (per channel)	Switch substitute value/ hold last value	Switch substitute value/ hold last value	Switch substitute value/ hold last value	Switch substitute value/ hold last value
Substitute value (per channel)	0/1 (Default: 0)	0/1 (Default: 0)	0/1 (Default: 0)	0/1 (Default: 0)
Online simulation (per channel)	Lock/unlock; simulation value: 0/1	Lock/unlock; simulation value: 0/1	Lock/unlock; simulation value: 0/1	Lock/unlock; simulation value: 0/1
Diagnostics (per channel)	Short circuit, wire break (actuators)	Short circuit, wire break (actuators)	Short circuit, wire break (actuators)	Short circuit, wire break (actuators)
Diagnostics (per module)	Undervoltage ( $U_{LS} + U_A$ )	Undervoltage ( $U_{LS} + U_A$ )	Undervoltage ( $U_{LS} + U_A$ )	Undervoltage ( $U_{LS} + U_A$ )

*continued on next page*

See index Page 73 for GoTo product and accessory part numbers.

GoTo Focused Delivery Program: I/O

## IndraControl S67 – Digital Output Modules (continued)

### Digital Outputs (continued)

<b>Process image</b>				
Process data width	1 byte data + status	1 byte data + status	1 byte data + status	1 byte data + status
<b>Ambient conditions</b>				
Permissible temperature (operation)	-25 to +60 °C	-25 to +60 °C	-25 to +60 °C	-25 to +60 °C
Permissible relative humidity (operation)	5 to 95 %	5 to 95 %	5 to 95 %	5 to 95 %
Permissible air pressure (operation)	795 to 1,080 hPa	795 to 1,080 hPa	795 to 1,080 hPa	795 to 1,080 hPa
<b>Mechanical data</b>				
Dimensions (W x H x D)	50 x 117 x 35 mm	50 x 117 x 35 mm	50 x 117 x 35 mm	50 x 117 x 35 mm

See index Page 73 for GoTo product and accessory part numbers.

GoTo Focused Delivery Program: I/O

# IndraControl S67 – Analog Input Modules

	<p>IP67 Analog Input Modules – Mounted on the machine for acquiring analog signals from standard sensors, e.g. temperature or pressure sensors.</p> <p>For complete engineering and design information:  <b>GoTo <a href="http://www.boschrexroth-us.com/GoToIO">www.boschrexroth-us.com/GoToIO</a></b></p>
--	---

## Features

- Extremely fast cycle times thanks to optimized data transmission
- Largest measuring range compared to competitive equivalent

## Analog Inputs

Technical data	S67-AI4-U/I-M12
<b>Analog inputs</b>	
Number	4
Connection type	M12 connectors, A coded, 5 poles
Type of signal	Currents and voltages (differential inputs)
Sensor connection type	2- to 4-wire connection (external shield via knurled nut)
Measuring range	0 to 20 mA, 4 to 20 mA, ±20 mA, 0 to 10 V, ±10 V
Cable length	≤ 30 m
<b>Analog value creation</b>	
Resolution	16 bit
Conversion time	1 ms
Sampling delay	1 ms (Modul), < 100 µs (channel/channel)
Sampling repeat time	1 ms
<b>Failures and errors</b>	
Max. measuring error at 25 °C	ca. ±0.2 % the measuring range
Temperature error	ca. ±0.01 % the measuring range/K
<b>Configurable functions</b>	
Measuring range (per channel)	0 to 20 mA, 4 to 20 mA, ±20 mA, 0 to 10 V, ±10 V
Limiting values (per channel)	Lock/unlock
Input filter (per channel)	Low pass
Sampling duration (per channel)	1, 2, 4, 8 ms
Interference frequency suppression (per channel)	50/60 Hz
Online simulation (per channel)	Lock/unlock, simulation value (according to measuring range)

*continued on next page*

See index Page 73 for GoTo product and accessory part numbers.

GoTo Focused Delivery Program: I/O

## IndraControl S67 – Analog Input Modules (continued)

### Analog Inputs (continued)

<b>Configurable functions</b>	
Diagnostics (per module)	Undervoltage ( $U_{LS} + U_A$ ) Short circuit (sensor power supply) Wire break (sensor power supply) Limit value violation Overrange/measuring range underflow
<b>Process image</b>	
Process data width	8 byte data + status
<b>Ambient conditions</b>	
Permissible temperature (operation)	-25 to +60 °C
Permissible relative humidity (operation)	5 to 95 %
Permissible air pressure (operation)	795 to 1,080 hPa
<b>Mechanical data</b>	
Dimensions (W x H x D)	50 x 177 x 35 mm

See index Page 73 for GoTo product and accessory part numbers.

GoTo Focused Delivery Program: I/O

# IndraControl S67 – Analog Output Modules

	<p>IP67 Analog Output Modules – Mounted on the machine for outputting analog signals for external controls.</p> <p>For complete engineering and design information: GoTo <a href="http://www.boschrexroth-us.com/GoToIO">www.boschrexroth-us.com/GoToIO</a></p>
---	---

## Features

- Online simulation
- Event driven signal substitution
- Largest measuring range compared to competition

## Analog Outputs

Technical data	S67-AO4-U/I-M12
<b>Analog outputs</b>	
Number	4
Connection type	M12 connectors, A coded, 5 poles
Type of signal	Currents and voltages
Sensor connection type	2- to 4-wire connection (external shield via knurled nut)
Measuring range	0 to 20 mA, 4 to 20 mA, ±20 mA, 0 to 10 V, ±10 V
Output load (load impedance)	≤ 500 Ω (current) ; ≥ 5 kΩ (voltage)
Maximum capacitive load (at voltage outputs)	10 nF
Maximum inductive load (at current outputs)	1 mH
Cable length	≤ 30 m
<b>Analog value creation</b>	
Resolution	15 bit (unipolar), 16 bit (bipolar)
Monotony	Yes
Cycle time	Typ. 1 ms
Recovery time for resistive, inductive and capacitive loads	Typ. 1 ms
<b>Failures and errors</b>	
Max. measuring error at 25 °C	≤ ±0.2 % the measuring range
Overshooting	Typ. ±0.05 % the measuring range
Output ripple	Typ. ±0.02 % the measuring range
Crosstalk between the channels at DC voltage and AC voltage 50 Hz and 60 Hz	-90 dB
Short circuit protection	Electronic
Nominal output current	Max. 1 A

*continued on next page*

See index Page 73 for GoTo product and accessory part numbers.

GoTo Focused Delivery Program: I/O

## IndraControl S67 – Analog Output Modules (continued)

### Analog Outputs (continued)

<b>Configurable functions</b>	
Measuring range (per channel)	0 to 20 mA, 4 to 20 mA, $\pm 20$ mA, 0 to 10 V, $\pm 10$ V
Substitute value strategy (per channel)	Switch substitute value/hold last value
Substitute value (per channel)	0 mA or 0 V/substitute value according to measuring range (Default: 0 mA or 0 V)
Online simulation (per channel)	Lock/unlock, simulation value (according to measuring range)
Diagnostics (per module)	Short circuit (actuator supply), wire break (current), undervoltage ( $U_{LS} + U_A$ )
<b>Process image</b>	
Process data width	8 byte data + status
<b>Ambient conditions</b>	
Permissible temperature (operation)	-25 to +60 °C
Permissible relative humidity (operation)	5 to 95 %
Permissible air pressure (operation)	795 to 1,080 hPa
<b>Mechanical data</b>	
Dimensions (W x H x D)	50 x 117 x 35 mm

See index Page 73 for GoTo product and accessory part numbers.



GoTo Focused Delivery Program: I/O

# IndraControl S67 – Temperature Modules



IP67 RTD Signal Input Modules – Mounted on the machine for analog signals from temperature sensors.

For complete engineering and design information:  
GoTo [www.boschrexroth-us.com/GoToIO](http://www.boschrexroth-us.com/GoToIO)

## Features

- Configurable diagnostic threshold
- Online simulation
- Largest measuring range compared to competition

## Temperature Modules

Technical data	S67-AI4-RTD-M12
<b>Analog inputs</b>	
Number	4
Connection type	M12 connectors, A coded, 5 poles
Type of signal	Resistance thermometers, resistors, potentiometers
Sensor connection type	2- to 4-wire connection (external shield via knurled nut)
Signal measuring range	Resistance thermometer: PT100, PT200, PT500, PT1000, NI100, NI120, NI1000; Resistors: 1 kΩ and 4 kΩ; Potentiometer: 0 to 100 % setting angle (for 1.25 kΩ and 4 kΩ); Free characteristics: PT 3000, NTC etc.
Temperature range	PT: -200 to +850 °C, NI: -60 to +250 °C
Cable length	≤ 30 m
<b>Analog value creation</b>	
Resolution	16 bit
Input filter	16.7 Hz, 33 Hz, 50 Hz, 60 Hz, 120 Hz, 250 Hz, 500 Hz
<b>Failures and errors</b>	
Max. measuring error at 25 °C	±0.1 % the measuring range
Temperature error	±0.001 % the measuring range/K
<b>Configurable functions</b>	
Measuring range (per channel)	PT100, PT200, PT500, PT1000, NI100, NI120, NI1000; Resistors: 1 kΩ and 4 kΩ; Potentiometer: 0 to 100 % setting angle (for 1 kΩ and 4 kΩ); Free characteristics: PT 3000, NTC
Connection type	2-, 3-, 4-wire connection
Limiting values (per channel)	Lock/unlock, Min1/Min2/Max1/Max2
Input filter (per channel)	16.7 Hz, 33 Hz, 50 Hz, 60 Hz, 120 Hz, 250 Hz, 500 Hz

*continued on next page*

See index Page 73 for GoTo product and accessory part numbers.

GoTo Focused Delivery Program: I/O

## IndraControl S67 – Temperature Modules (continued)

### Temperature Modules (continued)

<b>Configurable functions</b>	
Diagnostics (per module)	Undervoltage ( $U_{LS} + U_A$ ) Wire break (sensor power supply) Limit value violation Overrange/measuring range underflow
<b>Process image</b>	
Process data width	8 byte data + status
<b>Ambient conditions</b>	
Permissible temperature (operation)	-25 to +60 °C
Permissible relative humidity (operation)	5 to 95 %
Permissible air pressure (operation)	795 to 1,080 hPa
<b>Mechanical data</b>	
Dimensions (W x H x D)	50 x 177 x 35 mm

See index Page 73 for GoTo product and accessory part numbers.

GoTo Focused Delivery Program: I/O

# IndraControl S67 – Cabling

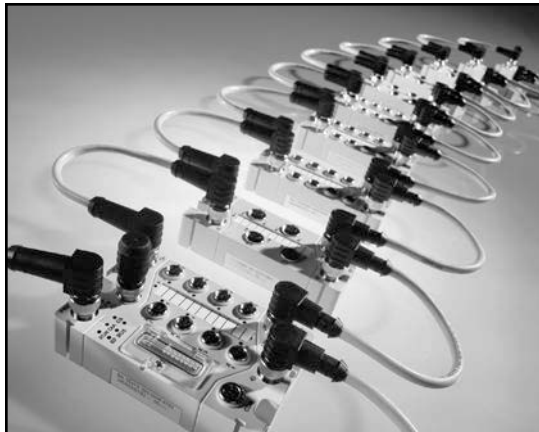

IP67 ready-made cables for easy system connectivity on the machine.

For complete engineering and design information:  
GoTo [www.boschrexroth-us.com/GoToIO](http://www.boschrexroth-us.com/GoToIO)

## Technical Data

S67 Profibus Cables	Type code	Length
Bus cable PROFIBUS DP, shielded, 5-pin, PUR M12 plug, straight, B-coded – open end	IKB0048/005.0	5.0 m
Bus cable PROFIBUS DP, shielded, 5-pin, PUR M12 socket, straight, B-coded – open end	IKB0049/005.0	5.0 m
Bus cable PROFIBUS DP, shielded, 5-pin, PUR M12 plug, straight, B-coded – M12 socket, straight, B-coded	IKB0050/000.3	0.3 m
M12 terminating resistor, PROFIBUS, 5 pins, B-coded	INS0762/CNN	
Voltage and System Bus Cables		
Voltage cable, unshielded 4-pin, 0.75 mm <sup>2</sup> , PUR M12 socket, straight, A-coded – open end	RKB0047/005.0	5.0 m
Voltage cable, not shielded, 4-pin, 0.75 mm <sup>2</sup> , PUR M12 connector, straight, A-coded – M12 socket, straight, A-coded	RKB0046/000.2	0.2 m
Systembus cable, M12 plug, M12 connector	RKB0041/000.2	0.2 m
Systembus termination plug, M12 connector	RBS0020/CNN	

See index Page 73 for GoTo product and accessory part numbers.

GoTo Focused Delivery Program: HMI

# Standard HMI



Operator Terminals with small footprints to save on panel space. Can connect to a number of 3rd party products. Recipes and other powerful capabilities available.

For complete engineering and design information:  
**GoTo [www.boschrexroth-us.com/GoToHMI](http://www.boschrexroth-us.com/GoToHMI)**

## Features

- Pushbutton and Touchscreen available
- Color and Greyscale available
- All terminals have Ethernet and USB ports

## Technical Data

	VCP 02	VCP 05	VCP 08	VCP 11	VCP 25	VCP 35
Display	FSTN			FSTN-Touch	STN-color-Touch	TFT-Touch
	5 grey tones			5 grey tones	125 colors	65,535 colors
	3"	3"	3.8"	3.8"	5.7"	10.4"
Resolution	160 x 80	160 x 80	320 x 240	320 x 240	320 x 240, 1/4 VGA	640 x 480
Keyboard/touch	Foil keys			Touchscreen	Touchscreen	Touchscreen
Application memory	3 MB					
Flash memory	16 MB					
Slot for expansions	1					
Line voltage	24 V DC					
Interfaces*	1 x Ethernet TCP/IP, 2 x USB host					
Front protection degree	IP65					
Dimensions (W x H x D)	144 x 96 x 58 mm	120 x 168 x 55 mm	155 x 205 x 55 mm	130 x 96 x 55 mm	203 x 147 x 66 mm	328 x 249 x 60 mm

\*Additional communication options available, but not covered by GoTo program

See index Page 73 for GoTo product and accessory part numbers.

GoTo Focused Delivery Program: HMI

# Embedded HMI



Powerful HMIs with great networking and 3rd party connectivity. Recipes, trending and other MES-like functionality available and easily implemented.

For complete engineering and design information:  
**GoTo [www.boschrexroth-us.com/GoToHMI](http://www.boschrexroth-us.com/GoToHMI)**

## Features

- Touchscreens
- Multiple ports including USB, Ethernet and Serial available onboard
- Allows for connection to any product that supports OPC

## Technical Data

	VEP 30.4	VEP 40.4	VEP 50.4
Display	8.4" – TFT	12.1" – TFT	15" – TFT
Resolution	800 x 600, SVGA	800 x 600, SVGA	1,024 x 768, XGA
Touchscreen	Yes		
Processor	Intel Atom Prozessor 1,1 GHz.		
RAM	1 GB		
Compact flash	2 CF-Sockel, Standard 1 GB CF-Card , or optional 4 GB CF-Card		
Module slots	–		
USB	3 (1 x Front)		
Ethernet TCP/IP	1		
Supply voltage	24 V DC		
Operating system	Windows CE 6.0 / Window Xpe		
Approvals	CE/UL/CSA		
Front protection degree	IP65		
Dimensions (W x H x D)	296 x 200 x 53 mm	350 x 290 x 51 mm	407 x 370 x 53 mm

Firmware	
FWA-VEP*04-CWN-10VRS-D0-A*	Firmware for IndraControl VEPxx.4-Atom (Windows CE 6.0) and WinStudio 7 Lite Runtime License
FWA-VEP*04-XPE-01VRS-D0-A*	Firmware for IndraControl VEPxx.4-Atom (Windows Xpe)

Software w/ license option	
SWA-IWORKS-ML*-12VRS-D0-INST*	Software Installation WinStudio 7.2 SP4 (Windows Xpe)
SWL-IWORKS-ML*-NNVRS-D0-COM	Single license – OPC / WinStudio lite (Windows Xpe)

WinStudio Runtime License	
SWS-WINSTU-RUN-07VRS-D0-1K5	Winstudio 07VRS Runtime single license 1.5K variables (Windows Xpe)
SWS-WINSTU-RUN-07VRS-D0-WCE1K5	Winstudio 7 Runtime single license 1.5K variables (Windows CE 6.0)

See index Page 74 for GoTo product and accessory part numbers.

GoTo Focused Delivery Program: Software

## IndraWorks

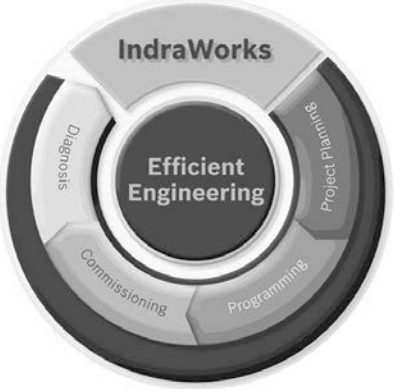
	<p>IndraWorks – a complete software suite can program HMIs, PLCs, drives and I/O systems in one IEC61131-3 environment.</p> <p>For complete engineering and design information: <b>GoTo <a href="http://www.boschrexroth-us.com/GoToSoftware">www.boschrexroth-us.com/GoToSoftware</a></b></p>
---	--

### Features

**Rexroth IndraWorks allows you to solve all tasks in a uniform and intuitive software environment—from project planning and programming to visualization and diagnostics.**

The uniform engineering framework IndraWorks is consistently available for all systems from the Rexroth Automation House. You, as a user, profit from the fast and transparent access to all functions and system data of the automation components. The standardized tools and interfaces help you to solve all engineering tasks centrally with a single piece of software.

#### Your benefits:

- Available for all systems and solutions from the Rexroth Automation House
- Integrated framework for all engineering tasks
- Consistent operating environment for project planning, programming, visualization and diagnostics
- Central project management with intuitive system navigation
- Intelligent operation with wizard support
- Comprehensive online help
- Uniform programming according to the PLC standard IEC 61131-3
- PLCopen-conforming function block and technology libraries
- Standardized interfaces for communication
- Transparent access to all system components
- Integrated FDT/DTM interface for integration of the DTM of third party manufacturers
- Software programs all Bosch Rexroth PLCs and VEP HMIs
- Optional IndraWorks Tool CamBuilder for IndraMotion available

See index Page 74 for GoTo product and accessory part numbers.

GoTo Focused Delivery Program: Software

## VI-Composer

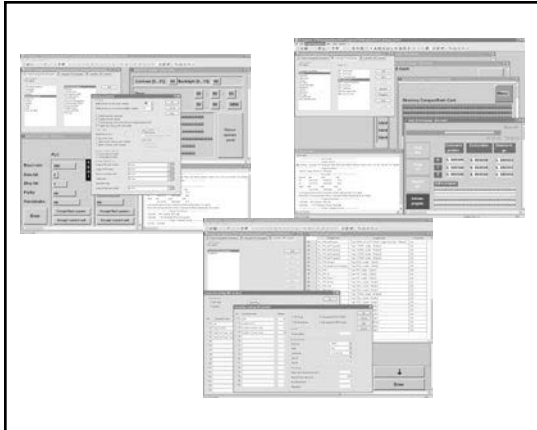

VI-Composer—efficient programming of your application in a convenient development environment.

For complete engineering and design information:  
GoTo [www.boschrexroth-us.com/GoToSoftware](http://www.boschrexroth-us.com/GoToSoftware)

### Features

**VI-Composer is an easy but powerful project development tool for the visualization and parameterization of system-related data of the IndraControl VCP and VCH devices. In this convenient development environment, you can efficiently create your individual application, based on the usual Windows look-and-feel. The programming result can then be used on the various IndraControl VCP and VCH devices as often as desired.**

The fully graphical VI-Composer software allows you to develop projects for IndraControl VCP and VCH devices according to the WYSIWYG (What You See Is What You Get) principle: text, variables and graphics are immediately represented just as they will be displayed by the IndraControl VCP and VCH devices. Predefined masks and comprehensive graphics libraries with numerous industry-compatible screen objects facilitate the creation of your applications. Based on Windows-conforming operation, you describe all variables depending on the particular control, whereas masks, graphics, recipes and the like can be created independently of any control. VI-Composer provides direct access to the IndraWorks database and, thus, to all variables of the controls and drives. The performance is completed by comprehensive help functions. The VCP HMIs are programmed via the VI-Composer.

#### Your benefits:



- Language management of the application with up to 16 languages
- Messaging and recording system
- Font editor for creating your own character sets
- Easy graphics incorporation via OLE
- Direct access to all control and drive variables
- Project and firmware download for reloadable functions
- Integrated creation of documentation and online help
- Predefined masks, curves and bar graphs
- Definition of free menu structures
- Screen elements: texts, variables, graphics, switches, buttons, drop-down list boxes, tables, etc.

See index Page 74 for GoTo product and accessory part numbers.





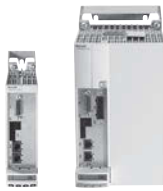

GoTo Focused Delivery Program: Part Numbers

Page Number	Product Type	Material Description	Part Number	Max. Qty.	Shipment (Business Days)
	<b>Drive Systems</b>				
	<b>IndraDrive Cs</b>				
7	Drive	HCS01.1E-W0006-A-02-B-ET-EC-NN-NN-NN-FW	R911325243	3	5
7	Drive	HCS01.1E-W0008-A-03-B-ET-EC-NN-NN-NN-FW	R911325246	5	5
7	Drive	HCS01.1E-W0013-A-02-B-ET-EC-NN-NN-NN-FW	R911325245	5	5
7	Drive	HCS01.1E-W0018-A-03-B-ET-EC-NN-NN-NN-FW	R911325247	5	5
7	Drive	HCS01.1E-W0018-A-03-B-ET-EC-NN-L4-NN-FW	R911331608	5	5
7	Drive	HCS01.1E-W0028-A-03-B-ET-EC-NN-NN-NN-FW	R911325248	5	5
7	Drive	HCS01.1E-W0028-A-03-B-ET-EC-NN-L4-NN-FW	R911331611	5	5
7	Drive	HCS01.1E-W0054-A-03-B-ET-EC-NN-NN-NN-FW	R911331185	1	5
7	Drive Firmware	FWA-INDRV*-MPB-16VRS-D5-1-ALL-NN	R911325610	5	5
7	Drive Firmware	FWA-INDRV*-MPB-17VRS-D5-1-ALL-ML	R911333290	5	5
7	Drive Firmware	FWA-INDRV*-MPB-17VRS-D5-1-ALL-NN	R911333280	5	5
7	Drive Firmware	FWA-INDRV*-MPB-17VRS-D5-1-NNN-NN	R911333283	5	5
7	Drive Firmware	FWA-INDRV*-MPB-17VRS-D5-1-SNC-NN	R911333284	5	5
	<b>IndraDrive C</b>				
8	Power Section	HCS02.1E-W0012-A-03-NNNN	R911298371	5	10
8	Power Section	HCS02.1E-W0028-A-03-NNNN	R911298374	5	10
8	Power Section	HCS02.1E-W0054-A-03-NNNN	R911298373	5	10
8	Power Section	HCS02.1E-W0070-A-03-NNNN	R911298372	5	10
9	Power Section	HCS03.1E-W0070-A-05-NNBV	R911308417	3	10
9	Power Section	HCS03.1E-W0100-A-05-NNBV	R911308419	3	10
9	Power Section	HCS03.1E-W0150-A-05-NNBV	R911308421	3	10
	<b>IndraDrive M – Inverters – single axis</b>				
10	Single Axis Inverter	HMS01.1N-W0020-A-07-NNNN	R911295323	5	10
10	Single Axis Inverter	HMS01.1N-W0036-A-07-NNNN	R911295324	5	10
10	Single Axis Inverter	HMS01.1N-W0054-A-07-NNNN	R911295325	5	10
10	Single Axis Inverter	HMS01.1N-W0070-A-07-NNNN	R911295326	5	10
10	Single Axis Inverter	HMS01.1N-W0110-A-07-NNNN	R911310462	5	10
10	Single Axis Inverter	HMS01.1N-W0150-A-07-NNNN	R911297164	5	10
10	Single Axis Inverter	HMS01.1N-W0210-A-07-NNNN	R911295328	1	10
	<b>Inverters – double axis</b>				
11	Double Axis Inverter	HMD01.1N-W0012-A-07-NNNN	R911306439	5	10
11	Double Axis Inverter	HMD01.1N-W0020-A-07-NNNN	R911295322	5	10
11	Double Axis Inverter	HMD01.1N-W0036-A-07-NNNN	R911298766	5	10

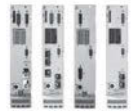
GoTo Focused Delivery Program: Part Numbers

Page Number	Product Type	Material Description	Part Number	Max. Qty.	Shipment (Business Days)
	<b>IndraDrive M – Power Supplies</b>				
12	Power Supply	HMV01.1E-W0030-A-07-NNNN	R911296724	1	10
12	Power Supply	HMV01.1E-W0075-A-07-NNNN	R911297424	1	10
12	Power Supply	HMV01.1R-W0018-A-07-NNNN	R911297460	1	10
12	Power Supply	HMV01.1R-W0045-A-07-NNNN	R911296725	1	10
12	Power Supply	HMV01.1R-W0065-A-07-NNNN	R911297426	1	10
	<b>IndraDrive C and M</b>				
14	Control Section	CSB01.1C-CO-ENS-NNN-NN-S-NN-FW	R911312378	5	10
14	Control Section	CSB01.1C-ET-ENS-EN2-NN-S-NN-FW	R911327307	5	10
14	Control Section	CSB01.1C-ET-ENS-NNN-NN-S-NN-FW	R911326813	5	10
14	Control Section	CSB01.1C-PB-ENS-NNN-NN-S-NN-FW	R911305278	5	10
14	Control Section	CSB01.1C-PL-ENS-NNN-NN-S-NN-FW	R911307286	5	10
14	Control Section	CSB01.1C-S3-ENS-EN2-NN-S-NN-FW	R911315253	5	10
14	Control Section	CSB01.1C-S3-ENS-NNN-L2-S-NN-FW	R911328086	5	10
14	Control Section	CSB01.1C-S3-ENS-NNN-NN-S-NN-FW	R911313871	5	10
14	Control Section	CSB01.1C-SE-ENS-EN2-NN-S-NN-FW	R911305500	5	10
14	Control Section	CSB01.1C-SE-ENS-NNN-NN-S-NN-FW	R911305277	5	10
14	Control Section	CSB01.1N-AN-ENS-NNN-NN-S-NN-FW	R911305274	5	10
14	Control Section	CSB01.1N-FC-NNN-NNN-NN-S-NN-FW	R911305273	5	10
14	Control Section	CSB01.1N-PB-ENS-NNN-NN-S-NN-FW	R911305275	5	10
14	Control Section	CSB01.1N-SE-ENS-NNN-NN-S-NN-FW	R911305276	5	10
14	Control Section	CSH01.1C-ET-ENS-NNN-NNN-S2-S-NN-FW	R911328178	5	10
14	Control Section	CSH01.1C-S3-EN2-NNN-NNN-S2-S-NN-FW	R911328094	5	10
14	Control Section	CSH01.1C-S3-ENS-NNN-NNN-NN-S-NN-FW	R911312309	5	10
14	Control Section – MLD Master	CSH01.3C-ET-ENS-NNN-CCD-NN-S-NN-FW	R911327303	5	10
14	Control Section – MLD Master	CSH01.3C-ET-ENS-NNN-CCD-S2-S-NN-FW	R911328005	5	10
14	Control Section – MLD Master	CSH01.3C-NN-ENS-EN2-CCD-NN-S-NN-FW	R911326825	5	10
14	Control Section – MLD Master	CSH01.3C-NN-ENS-NNN-CCD-NN-S-NN-FW	R911328912	5	10
14	Control Section – MLD Master	CSH01.3C-PL-ENS-EN2-CCD-NN-S-NN-FW	R911327681	5	10
14	Control Section – Double Axis	CDB01.1C-S3-ENS-ENS-NNN-NNN-NN-S-NN-FW	R911315255	5	10
16	Drive Firmware	FWA-INDRV*-MPB-05VRS-D5-1-NNN-NN	R911318477	5	10
16	Drive Firmware	FWA-INDRV*-MPB-05VRS-D5-1-SNC-NN	R911318479	5	10
16	Drive Firmware	FWA-INDRV*-MPB-07VRS-D5-0-NNN-NN	R911328698	5	10
16	Drive Firmware	FWA-INDRV*-MPB-07VRS-D5-1-NNN-NN	R911328706	5	10
16	Drive Firmware	FWA-INDRV*-MPB-07VRS-D5-1-SNC-NN	R911328708	5	10
16	Drive Firmware	FWA-INDRV*-MPH-07VRS-D5-1-NNN-NN	R911328741	5	10
16	Drive Firmware	FWA-INDRV*-MPH-07VRS-D5-1-SNC-NN	R911328743	5	10
16	Drive Firmware	FWA-INDRV*-MPH-08VRS-D5-1-NNN-NN	R911334747	5	10
16	Drive Firmware – MLD Master	FWA-INDRV*-MPC-07VRS-D5-1-ALL-MA	R911328767	5	10
16	Drive Firmware – MLD Master	FWA-INDRV*-MPC-07VRS-D5-1-NNN-ML	R911328760	5	10
16	Drive Firmware – MLD Master	FWA-INDRV*-MPC-07VRS-D5-1-SNC-ML	R911328762	5	10

GoTo Focused Delivery Program: Part Numbers

Page Number	Product Type	Material Description	Part Number	Max. Qty.	Shipment (Business Days)
	<b>IndraDrive C and M</b> continued				
16	Drive Firmware – MLD Master	FWA-INDRV*-MPC-08VRS-D5-1-NNN-ML	R911334717	5	10
16	Drive Firmware – Double Axis	FWA-INDRV*-MPD-07VRS-D5-1-NNN-NN	R911328716	5	10
16	Drive Firmware – Double Axis	FWA-INDRV*-MPD-07VRS-D5-1-SNC-NN	R911328717	5	10
16	Software Module	PFM02.1-016-FW	R911296958	10	10
	<b>IndraDyn S – MSK</b>				
17	MSK – Motor	MSK030C-0900-NN-M1-UG0-NNNN	R911308683	3	10
17	MSK – Motor	MSK030C-0900-NN-M1-UG1-NNNN	R911308684	3	10
17	MSK – Motor	MSK030C-0900-NN-M1-UP0-NNNN	R911308691	3	10
17	MSK – Motor	MSK030C-0900-NN-M1-UP1-NNNN	R911308692	3	10
17	MSK – Motor	MSK040B-0600-NN-M1-UG0-NNNN	R911306058	3	10
17	MSK – Motor	MSK040B-0600-NN-M1-UG1-NNNN	R911306059	3	10
17	MSK – Motor	MSK040C-0450-NN-M1-UP0-NNNN	R911320614	3	10
17	MSK – Motor	MSK040C-0450-NN-M1-UP1-NNNN	R911320757	3	10
17	MSK – Motor	MSK040C-0600-NN-M1-UG0-NNNN	R911306060	3	10
17	MSK – Motor	MSK040C-0600-NN-M1-UG1-NNNN	R911306061	3	10
17	MSK – Motor	MSK040C-0600-NN-M1-UP0-NNNN	R911306387	3	10
17	MSK – Motor	MSK040C-0600-NN-M1-UP1-NNNN	R911306388	3	10
17	MSK – Motor	MSK040C-0600-NN-S1-UP0-NNNN	R911306383	3	10
17	MSK – Motor	MSK050C-0600-NN-M1-UP0-NNNN	R911299914	3	10
17	MSK – Motor	MSK050C-0600-NN-M1-UP1-NNNN	R911299915	3	10
17	MSK – Motor	MSK060C-0300-NN-M1-UP0-NNNN	R911307221	3	10
17	MSK – Motor	MSK060C-0300-NN-M1-UP1-NNNN	R911307222	3	10
17	MSK – Motor	MSK061C-0600-NN-M1-UP0-NNNN	R911317019	3	10
17	MSK – Motor	MSK061C-0600-NN-M1-UP1-NNNN	R911317757	3	10
17	MSK – Motor	MSK061C-0600-NN-S1-UG0-NNNN	R911312032	3	10
17	MSK – Motor	MSK071E-0300-NN-M1-UP0-NNNN	R911311899	3	10
17	MSK – Motor	MSK071E-0300-NN-M1-UP1-NNNN	R911313947	3	10
17	MSK – Motor	MSK071E-0450-NN-M1-UG0-NNNN	R911310383	3	10
17	MSK – Motor	MSK071E-0450-NN-M1-UG1-NNNN	R911311789	3	10
17	MSK – Motor	MSK076C-0300-NN-M1-UP0-NNNN	R911316339	3	10
17	MSK – Motor	MSK076C-0300-NN-M1-UP1-NNNN	R911317624	3	10
17	MSK – Motor	MSK100B-0300-NN-M1-BP0-NNNN	R911315350	2	10
17	MSK – Motor	MSK100B-0300-NN-M1-BP1-NNNN	R911316856	2	10
17	MSK – Motor	MSK100C-0300-NN-M1-BP0-NNNN	R911311545	2	10
17	MSK – Motor	MSK100C-0300-NN-M1-BP2-NNNN	R911317729	2	10
17	MSK – Motor	MSK101D-0450-NN-M1-BP0-NNNN	R911311852	2	10
17	MSK – Motor	MSK101D-0450-NN-M1-BP2-NNNN	R911333387	2	10





## GoTo Focused Delivery Program: Part Numbers

Page Number	Product Type	Material Description	Part Number	Max. Qty.	Shipment (Business Days)
	<b>IndraDyn S – MSM</b>				
19	MSM – Motor	MSM019B-0300-NN-M0-CH0	R911325131	3	10
19	MSM – Motor	MSM019B-0300-NN-M0-CH1	R911325132	3	10
19	MSM – Motor	MSM031B-0300-NN-M0-CH0	R911325135	3	10
19	MSM – Motor	MSM031C-0300-NN-M0-CH0	R911325139	3	10
19	MSM – Motor	MSM031C-0300-NN-M0-CH1	R911325140	3	10
19	MSM – Motor	MSM041B-0300-NN-M0-CH0	R911325143	3	10
19	MSM – Motor	MSM041B-0300-NN-M0-CH1	R911325144	3	10
	<b>Additional Components</b>				
20	Line Filter	NFD03.1-480-007	R911286917	2	3
20	Line Filter	NFD03.1-480-016	R911286918	2	3
20	Line Filter	NFD03.1-480-030	R911286919	2	3
20	Line Filter	NFD03.1-480-055	R911286920	2	3
20	Line Filter	NFD03.1-480-075	R911286922	1	3
20	Line Filter	NFD03.1-480-130	R911286923	1	3
20	Breaking Resistor	HLB01.1C-01K0-N06R0-A-007-NNNN	R911299878	1	5
20	Breaking Resistor	HLB01.1D-02K0-N03R4-A-007-NNNN	R911299879	1	5
20	Capacitor Module	HLC01.1C-02M4-A-007-NNNN	R911308870	1	5
20	Capacitor Module	HLC01.1D-05M0-A-007-NNNN	R911308869	1	5
21	Basic Kit	HAS01.1-050-072-MN	R911306620	5	5
21	Basic Kit	HAS01.1-065-072-CN	R911311807	5	5
21	Basic Kit	HAS01.1-065-NNN-CN	R911306007	5	5
21	Basic Kit	HAS01.1-075-072-MN	R911306619	5	5
21	Basic Kit	HAS01.1-100-072-MN	R911306621	5	5
21	Basic Kit	HAS01.1-105-NNN-CN	R911306008	5	5
21	Basic Kit	HAS01.1-105-072-CN	R911311808	5	5
21	Basic Kit	HAS01.1-125-072-CN	R911306664	5	5
21	Basic Kit	HAS01.1-150-072-MN	R911306622	5	5
21	Basic Kit	HAS01.1-175-072-MN	R911306623	5	5
21	Basic Kit	HAS01.1-200-072-MN	R911306624	5	5
21	Basic Kit	HAS01.1-225-072-CN	R911306666	5	5
21	Basic Kit	HAS01.1-250-072-MN	R911306625	5	5
21	Basic Kit	HAS01.1-350-072-MN	R911306626	5	5
21	Shield Kit	HAS02.1-001-NNN-NN	R911306330	5	5
21	Shield Kit	HAS02.1-002-NNN-NN	R911306106	5	5
21	Shield Kit	HAS02.1-003-NNN-NN	R911306331	5	5
21	Shield Kit	HAS02.1-004-NNN-NN	R911306720	5	5
21	Shield Kit	HAS02.1-005-NNN-NN	R911306721	5	5
21	X41 Connection Adapter	HAS05.1-007-NNL-NN	R911321502	10	10
21	X41 Connection Adapter	HAS05.1-007-NNR-NN	R911319770	10	10



GoTo Focused Delivery Program: Part Numbers

Page Number	Product Type	Material Description	Part Number	Max. Qty.	Shipment (Business Days)
	<b>Cables</b>				
22	Motor Power	RKL0013/005.0 (5m length)	R911341663	3	10
22	Motor Power	RKL0013/000.0 (configurable length)	R911324290	3	12
22	Motor Power	RKL0014/005.0 (5m length)	R911342674	5	5
22	Motor Power	RKL0014/000.0 (configurable length)	R911324291	5	12
22	Motor Power	RKL0019/005.0 (5m length)	R911331348	5	5
22	Motor Power	RKL0019/010.0 (10m length)	R911331349	5	5
22	Motor Power	RKL0019/000.0 (configurable length)	R911325407	5	12
22	Motor Power	RKL0050/000.0 (configurable length)	R911332781	5	12
22	Motor Power	RKL4302/005.0 (5m length)	R911310648	5	5
22	Motor Power	RKL4302/010.0 (10m length)	R911310649	5	5
22	Motor Power	RKL4302/000.0 (configurable length)	R911305799	5	12
22	Motor Power	RKL4303/005.0 (5m length)	R911310652	5	5
22	Motor Power	RKL4303/010.0 (10m length)	R911310653	5	5
22	Motor Power	RKL4303/000.0 (configurable length)	R911305798	5	12
22	Motor Power	RKL4306/000.0 (configurable length)	R911305803	5	12
22	Motor Power	RKL4308/000.0 (configurable length)	R911305801	5	12
22	Motor Power	RKL4309/005.0 (5m length)	R911312870	5	5
22	Motor Power	RKL4309/000.0 (configurable length)	R911305180	5	12
22	Motor Power	RKL4321/000.0 (configurable length)	R911310460	5	12
22	Motor Power	RKL4324/005.0 (5m length)	R911337991	5	5
22	Motor Power	RKL4324/000.0 (configurable length)	R911310116	5	12
22	Motor Power	RKL4329/000.0 (configurable length)	R911311149	5	12
23	Motor Feedback	RKG4200/005.0 (5m length)	R911310645	5	5
23	Motor Feedback	RKG4200/010.0 (10m length)	R911310646	5	5
23	Motor Feedback	RKG4200/000.0 (configurable length)	R911299435	5	12
23	Motor Feedback	RKG0033/005.0 (5m length)	R911342494	3	10
23	Motor Feedback	RKG0033/000.0 (configurable length)	R911324269	3	12
23	Motor Feedback	RKG0034/000.0 (configurable length)	R911326091	3	12
23	Interface (Optical)	RKO0100/00.25 (0.25m length)	R911308248	5	5
23	Interface (Optical)	RKO0101/005.0 (5m length)	R911308242	5	5
23	Interface (Optical)	RKO0101/010.0 (10m length)	R911308243	5	5
23	Interface (Ethernet)	RKB0011/005.0 (5m length)	R911321548	5	5
23	Interface (Ethernet)	RKB0011/000.0 (configurable length)	R911316888	5	12
23	Interface (Ethernet)	RKB0013/00.25 (0.25m length)	R911317797	5	5
23	Interface (RS232-Serial)	IKB0041/002.0 (2m length)	R911296708	5	5
23	Battery Box	SUP-E01-MSM-BATTERYBOX	R911324240	3	10
23	Extension – Module Bus Connection	RKB0001/002.0 (2m length)	R911343983	1	10
23	Extension – Module Bus Connection	RKB0001/005.0 (5m length)	R911343984	1	10

## GoTo Focused Delivery Program: Part Numbers

Page Number	Product Type	Material Description	Part Number	Max. Qty.	Shipment (Business Days)
	<b>Motion Control PAC</b>				
	<b>IndraControl L</b>				
24	IndraControl L25	CML25.1-3N-400-NN-NNC1-NW	R911171363	1	5
24	IndraControl L40	CML40.2-SP-330-NA-NNNN-NW	R911170255	1	5
24	IndraControl L45	CML45.1-3P-500-NA-NNNN-NW	R911170828	1	5
24	IndraControl L45	CML45.1-3P-504-NA-NNNN-NW	R911170827	1	5
24	IndraControl L65	CML65.1-3P-500-NA-NNNN-NW	R911170900	1	5
24	IndraControl L65	CML65.1-3P-504-NA-NNNN-NW	R911170899	1	5
24	Connector Set (L40, L45, L65)	R-IB IL CML S01-PLSET	R911299856	10	5
	<b>IndraControl L – Function Modules</b>				
25	Cross Communication	CFL01.1-Q2	R911170009	1	5
25	Sercos 3 Interface	CFL01.1-R3	R911170008	1	5
25	RT-Ethernet/ PROFIBUS	CFL01.1-TP	R911170832	1	5
26	Programmable Limit Switch	CFL01.1-N1	R911170012	1	5
	<b>IndraMotion MLC</b>				
27	Firmware	FWA-CML25*-MLC-11VRS-D0	R911331629	1	5
27	Firmware	FWA-CML25*-MLC-12VRS-D0	R911334607	1	5
27	Firmware	FWA-CML402-MLC-04VRS-D0	R911320567	1	5
27	Firmware	FWA-CML45*-MLC-11VRS-D0	R911331630	1	5
27	Firmware	FWA-CML45*-MLC-12VRS-D0	R911334609	1	5
27	Firmware	FWA-CML65*-MLC-12VRS-D0	R911334611	1	5
	<b>IndraLogic XLC</b>				
28	Firmware	FWA-CML25*-XLC-12VRS-D0	R911334606	1	5
28	Firmware	FWA-CML45*-XLC-12VRS-D0	R911334608	1	5

GoTo Focused Delivery Program: Part Numbers

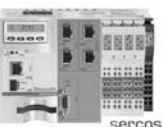

Page Number	Product Type	Material Description	Part Number	Max. Qty.	Shipment (Business Days)
	<b>Safety Control</b>				
	<b>SafeLogic compact</b>				
29	CPU1 with EFI interface	SLC-3-CPU130302	R911172285	1	10
29	Safety Control (CPU)	SLC-3-CPU000300	R911172284	1	10
29	8 Digital Safety Inputs	SLC-3-XTDI80302	R911172292	5	10
29	8 Digital Safety Inputs / 4 Digital Safety Outputs	SLC-3-XTIO84302	R911172291	5	10
29	Sercos III Gateway (CSoS)	SLC-3-GS3S00300	R911172765	2	10
29	Relay: 2 NO, 1 NC	SLC-A-UE10-2FG3D0	R911172295	2	10
	Relay: 2 NO, 1 NC, 1 24V	SLC-A-UE410-2RO4	R911172293	2	10
29	Relay: 2 NO, 1 NC, cascadable	SLC-A-UE12-2FG3D0	R911172296	3	10
29	Relay: 2x (2 NO, 1 NC, 1 24V)	SLC-A-UE410-4RO4	R911172294	2	10
29	Memory plug	SLC-3-MPL000301	R911172286	2	10
29	Terminal set, dual-level spring-clamp type	SLC-A-PLSET02	R911172298	5	10
29	Terminal set, screw type	SLC-A-PLSET01	R911172297	5	10
29	Engineering cable	SLC-A-RS232/A/2.0	R911172299	1	10
29	SafeLogic Designer tool installation CD	SWA-SLC**-SLD-01VRS-D0-CD650-COPY	R911334897	1	1
	<b>CNC</b>				
	<b>IndraMotion MTX micro</b>				
30	Compact Converter	HCT02.1E-W0025-A-03-B-L8-2S-D1-NN-NN-FW	R911329652	1	15
30	Compact Converter	HCOQ02.1E-W0025-A-03-B-L8-1S-D1-D1-NN-FW	R911329660	1	15
30	Software Module	CFM01.1-01G0-N-LBA-01-FW	R911337003	1	15
30	Firmware	FWA-MICRO*-MTX-13VRS-NN	R911337488	1	15
30	License – Single – MTX micro	SWL-IWORKS-MTX-NNVRS-D0-MICRO	R911331698	1	15
30	Operating Panel – universal	VDP80.1FKN-C1-NN-EN	R911172321	1	15
30	Handwheel Box	VCH02.1NNN-000RS	R911328584	1	15
30	Operating Panel for turning machines	VDP80.1FGN-C1-NN-EN	R911172168	1	15
30	Interface (Firewire)	RKB0030/000,0 (configurable length)	R911327086	2	15
30	Digital I/O Module	DEA40.1H	R911320704	1	15
30	Choke	HNL01.1E-0400-N0051-A-480-NNNN	R911306580	1	15
30	Brake Resistor	HLR01.1N-02K0-N15R0-A-007-NNNN	R911306870	1	15
	<b>IndraMotion MTX</b>				
31	IndraControl L45	CML45.1-3P-504-NA-NNNN-NW	R911170827	1	5
31	IndraControl L65	CML65.1-3P-504-NA-NNNN-NW	R911170899	1	5

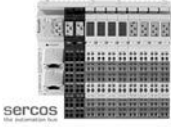
## GoTo Focused Delivery Program: Part Numbers



Page Number	Product Type	Material Description	Part Number	Max. Qty.	Shipment (Business Days)
	<b>I/O</b>				
	<b>Inline (IP20)</b>				
32	Power Module	R-IB IL 24 PWR IN-PAC	R911170789	5	3
32	Power Module	R-IB IL 24 SEG/F-PAC	R911170790	5	3
32	Power Module	R-IB IL 24 SEG/F-D-PAC	R911170710	5	3
33	Bus Coupler	R-IL S3 BK DI8 DO4-PAC	R911170875	5	3
33	Bus Coupler	R-IL PB BK DI8 DO4/CN-PAC	R911172194	5	3
33	Bus Coupler	R-IL PB BK DP/V1-PAC	R911170971	5	3
34	Block I/O	R-ILB S3 24 DI16 DIO16	R911170826	5	3
35	Block I/O Analog	R-ILB S3 AI4 AO2	R911170874	5	3
36	Block I/O Analog SSI	R-ILB S3 AI12 AO4 SSI-IN4	R911171949	5	3
38	Digital Input Module	R-IB IL 24 DI 4-PAC	R911170750	5	3
38	Digital Input Module	R-IB IL 24 DI 8/HD-PAC	R911171972	5	3
38	Digital Input Module	R-IB IL 24 DI 8-PAC	R911170751	5	3
38	Digital Input Module	R-IB IL 24 DI 16-PAC	R911170752	5	3
38	Digital Input Module	R-IB IL 24 DI 32/HD-PAC	R911170753	5	3
39	Digital Output Module	R-IB IL 24 DO 2-2A-PAC	R911170754	5	3
39	Digital Output Module	R-IB IL 24 DO 4-PAC	R911170755	5	3
39	Digital Output Module	R-IB IL 24 DO 8/HD-PAC	R911171973	5	3
39	Digital Output Module	R-IB IL 24 DO 8-PAC	R911170756	5	3
39	Digital Output Module	R-IB IL 24 DO 8-2A-PAC	R911170759	5	3
39	Digital Output Module	R-IB IL 24 DO 16-PAC	R911170757	5	3
39	Digital Output Module	R-IB IL 24 DO 32/HD-PAC	R911170768	5	3
39	Digital Output Module	R-IB IL 24/230 DOR 1/W-PAC	R911170769	5	3
39	Digital Output Module	R-IB IL 24/230 DOR4/W-PAC	R911170758	5	3
41	Analog Input Module	R-IB IL AI 2/SF-PAC	R911170784	5	3
41	Analog Input Module	R-IB IL AI 8/IS-PAC	R911308494	5	3
41	Analog Input Module	R-IB IL AI 8/SF-PAC	R911308493	5	3
42	Analog Output Module	R-IB IL AO 2/U/BP-PAC	R911170786	5	3
42	Analog Output Module	R-IB IL AO 1/SF-PAC	R911170787	5	3
42	Analog Output Module	R-IB IL AO 2/SF-PAC	R911170436	5	3
43	Temperature Module	R-IB IL TEMP 2 RTD-PAC	R911170785	5	3
43	Temperature Module	R-IB IL TEMP 2 UTH-PAC	R911170431	5	3
44	Communication Module	R-IB IL RS232-PRO-PAC	R911170440	5	3
44	Communication Module	R-IB IL RS485/422-PRO-PAC	R911170442	5	3
45	Counter Module	R-IB IL CNT-PAC	R911170788	5	3
45	Counter Module	R-IB IL INC-IN-PAC	R911308491	5	3
45	Counter Module	R-IB IL SSI-PAC	R911308594	5	3
46	PWM Output Module	R-IB IL PWM/2-PAC	R911170444	5	3



GoTo Focused Delivery Program: Part Numbers

Page Number	Product Type	Material Description	Part Number	Max. Qty.	Shipment (Business Days)
	<b>IndraControl S67 (IP67)</b>				
48	Power Divider	S67-PWR-IN-M12	R911171796	5	3
49	Bus Coupler	S67-PB-BK-DI8-M8	R911171782	5	3
50	Digital Input Module	S67-DI8-M8	R911171787	5	3
50	Digital Input Module	S67-DI8-M12	R911171788	5	3
51	Digital Output Module	S67-DO8-M8	R911171789	5	3
51	Digital Output Module	S67-DO8-M12	R911171790	5	3
51	Digital Output Module	S67-DO8-M8-2A	R911171791	5	3
51	Digital Output Module	S67-DO8-M12-2A	R911171792	5	3
53	Analog Input Module	S67-AI4-U/I-M12	R911171793	5	3
55	Analog Output Module	S67-AO4-U/I-M12	R911171795	5	3
57	Temperature Module	S67-AI4-RTD-M12	R911171794	5	3
59	Profibus Cable	IKB0048/005.0 (5m length)	R911308301	3	5
59	Profibus Cable	IKB0049/005.0 (5m length)	R911308300	3	5
59	Profibus Cable	IKB0050/000.3 (0.3m length)	R911308250	3	5
59	Terminating Resistor	INS0762/CNN	R911296632	3	5
59	Voltage Cable	RKB0047/005.0 (5m length)	R911172100	3	5
59	Voltage Cable	RKB0046/000.2 (0.2m length)	R911172102	3	5
59	Systembus Cable	RKB0041/000.2 (0.2m length)	R911171990	3	5
59	Systembus Termination Plug	RBS0020/CNN	R911171998	5	3
	<b>HMI</b>				
	<b>Standard HMI</b>				
60	IndraControl VCP02	VCP02.2DRN-003-NN-NN-PW	R911311488	1	5
60	IndraControl VCP05	VCP05.2DSN-003-NN-NN-PW	R911311493	1	5
60	IndraControl VCP08	VCP08.2DTN-003-NN-NN-PW	R911311497	1	5
60	IndraControl VCP11	VCP11.2DWN-003-NN-NN-PW	R911311509	1	5
60	IndraControl VCP25	VCP25.2DVN-003-NN-NN-PW	R911311505	1	5
60	IndraControl VCP35	VCP35.2ECN-003-NN-NN-PW	R911171110	1	5

## GoTo Focused Delivery Program: Part Numbers

Page Number	Product Type	Material Description	Part Number	Max. Qty.	Shipment (Business Days)
	<b>Embedded HMI</b>				
61	IndraControl VEP30	VEP30.4EFN-512NN-A2D-NNN-NN-FW	R911171834	1	5
61	IndraControl VEP40	VEP40.4DBN-512NN-A2D-NNN-NN-FW	R911171835	1	5
61	IndraControl VEP50	VEP50.4DEN-512NN-A2D-NNN-NN-FW	R911171924	1	5
61	Firmware	FWA-VEP*04-CWN-10VRS-D0-A*	R911328967	1	5
61	WinStudio Runtime License	SWS-WINSTU-RUN-07VRS-D0-WCE1K5	R911323620	1	1
61	Firmware	FWA-VEP*04-XPE-01VRS-D0-A*	R911334113	1	5
61	Software Inst. – WinStudio 7.2 SP4	SWA-IWORKS-ML*-12VRS-D0-INST*	R911334633	1	5
61	License – Single – OPC/WinStudio Lite	SWL-IWORKS-ML*-NNVRS-D0-COM	R911332867	1	5
61	WinStudio Runtime License	SWS-WINSTU-RUN-07VRS-D0-1K5	R911323607	1	1
	<b>Software</b>				
	<b>IndraWorks</b>				
62	IndraWorks MLD11	SWA-IWORKS-MLD-11VRS-D0-DVD**-COPY	R911332831	1	1
62	IndraWorks MLD12	SWA-IWORKS-MLD-12VRS-D0-DVD**-COPY	R911335358	1	1
62	IndraWorks ML*04	SWA-IWORKS-ML*-04VRS-D0-CD650	R911320574	1	1
62	IndraWorks ML*11	SWA-IWORKS-ML*-11VRS-D0-DVD**	R911331633	1	1
62	IndraWorks ML*12	SWA-IWORKS-ML*-12VRS-D0-DVD**	R911334632	1	1
62	License ML*11 – Single	SWL-IWORKS-ML*-11VRS-D0-ENG	R911331635	1	1
62	License ML*12 – Single	SWL-IWORKS-ML*-12VRS-D0-ENG	R911334627	1	1
62	License XLC12 – Single	SWL-IWORKS-XLC-12VRS-D0-ENG	R911334612	1	1
62	IndraWorks CamBuilder11	SWS-IWORKS-CAM-11VRS-D0	R911331661	1	1
62	IndraWorks CamBuilder12	SWS-IWORKS-CAM-12VRS-D0	R911334634	1	1
63	VIComposer 02	SWA-VIC*PC-INB-02VRS-D0-CD650	R911311752	1	1



**Bosch Rexroth USA**

Headquarters  
14001 South Lakes Drive  
Charlotte, NC 28273  
Telephone (800) REXROTH  
(800) 739-7684  
info@boschrexroth-us.com  
www.boschrexroth-us.com/goto

**Bosch Rexroth Canada**

Headquarters  
490 Prince Charles Drive South  
Welland, ON L3B 5X7  
Telephone (855) REXROTH  
(855) 739-7684  
info@boschrexroth.ca  
www.boschrexroth.ca/goto

**Bosch Rexroth Mexico**

Neptuno 72, Unidad  
Industrial Vallejo  
Deleg. Gustavo A.  
Madero Mexico D.F. 07700  
Telephone: +52 (55) 57 47 0800  
ventas@boschrexroth.com.mx  
www.boschrexroth.com.mx/goto